

POWERTIP CORPORATION

SPECIFICATIONS





CUSTOMER : CUS999

SAMPLE CODE (Ver.) : PS320240WRF-JE8H04 (Ver.0)
(This Code will be changed while mass production)

MASS PRODUCTION CODE (Ver.) : _____

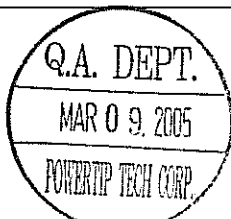
Customer Approved

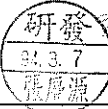
Date: _____

Approved	QC Confirmed	Designer
	 	<p style="text-align: center;">4/2 孫國峰</p> <div style="display: flex; justify-content: space-around;">   </div>

- Approval For Specifications Only.
- * This specification is subject to change without notice.
- Please contact Powertip or it's representative before designing your product based on this specification.
- Approval For Specifications and Sample.

Powertip Corporation

Headquarters:

No.8, 6th Road, Taichung Industrial Park,
 Taichung, Taiwan
 台中市 407 工業區六路 8 號

TEL: 886-4-2355-8168
 FAX: 886-4-2355-8166

E-mail: sales@powertip.com.tw
 Http://www.powertip.com.tw



RECORDS OF REVISION

Date	Rev.	Description	Note	Page
2005/2/21	0	New Sample		

Total : 21Page



Contents

1. SPECIFICATIONS

- 1.1 Features
- 1.2 Mechanical Specifications
- 1.3 Absolute Maximum Ratings
- 1.4 DC Electrical Characteristics
- 1.5 Optical Characteristics
- 1.6 Backlight Characteristics

2. MODULE STRUCTURE

- 2.1 Counter Drawing
- 2.2 Interface Pin Description
- 2.3 Timing Characteristics

3. QUALITY ASSURANCE SYSTEM

- 3.1 Quality Assurance Flow Chart
- 3.2 Inspection Specification

4. RELIABILITY TEST

- 4.1 Reliability Test Condition

5. PRECAUTION RELATING PRODUCT HANDLING

- 5.1 Safety
- 5.2 Handling
- 5.3 Storage
- 5.4 Terms of Warranty

Appendix: 1. LCM Drawing
2. Package

Note : For detailed information please refer to IC data sheet : EPSON D1370500A1
(Or comparable IC)

1. SPECIFICATIONS

1.1 Features

Item	Standard Value
Display Type	320 * 240 Dots
LCD Type	FSTN , Positive , Transflective
Driver Condition	LCD Module : 1/240 Duty , 1/14 Bias
Viewing Direction	6 O'clock
Backlight	LED B/L
Weight	70 g
Interface	8 bits parallel data input
Other(controller/driver IC)	Controller IC: EPSON D1370500A1

1.2 Mechanical Specifications

Item	Standard Value	Unit
Outline Dimension	92.0 (L) * 71.3 (w) * 7.9(H)(Max)	mm
Viewing Area	78.78 (L) * 59.58 (w)	mm
Active Area	76.78 (L) * 57.58 (w)	mm
Dot Size	0.22 (L) * 0.22 (w)	mm
Dot Pitch	0.24 (L) * 0.24 (w)	mm

Note : For detailed information please refer to LCM drawing

1.3 Absolute Maximum Ratings

Item	Symbol	Condition	Min.	Max.	Unit
Power Supply Voltage	V_{DD}	-	$V_{SS}-0.3$	4.0	V
LCD Driver Supply Voltage	$V_{EE}-V_{SS}$	-	-	32	V
Input Voltage	V_{IN}	-	$V_{SS}-0.3$	$V_{DD}+0.5$	V
Operating Temperature	T_{OP}	-	-20	70	°C
Storage Temperature.	T_{ST}	-	-30	80	°C
Storage Humidity	H_D	$T_a < 40\text{ °C}$	20	90	%RH

1.4 DC Electrical Characteristics

$V_{DD} = 3.3 V \pm 10\%$, $V_{SS} = 0V$, $T_a = 25^\circ C$

Item	Symbol	Condition	Min.	Typ.	Max.	Unit
Logic Supply voltage	V_{DD}	-	3.0	3.3	3.6	V
"H" input voltage	V_{IH}	-	2.0	-	-	V
"L" input voltage	V_{IL}	-	-	-	0.8	V
"H" output voltage	V_{OH}	-	$V_{DD}-0.4$	-	-	V
"L" output voltage	V_{OL}	-	-	-	0.4	V
Supply current	I_{DD}	$V_{DD} = 3.3 V$	-	21.0	50	mA
Operating current	I_{OP}	-	-	-	-	
LCM driving voltage	V_{OP}	$V_{OP} - V_{SS} (-20^\circ C)$	20.6	20.8	21.0	V
		$V_{OP} - V_{SS} (0^\circ C)$	20.3	20.6	20.9	
		$V_{OP} - V_{SS} (25^\circ C)$	20.3	20.6	20.9	
		$V_{OP} - V_{SS} (50^\circ C)$	20.1	20.4	20.7	
		$V_{OP} - V_{SS} (70^\circ C)$	19.9	20.1	20.3	

1.5 Optical Characteristics

LCD Panel : 1/240 Duty , 1/15 Bias , $V_{LCD} = 22.0V$, $T_a = 25^\circ C$

Item	Symbol	Conditions	Min.	Typ.	Max.	Reference
View Angle	θ	$C \geq 2.0, \varnothing = 0^\circ$	-40°	-	40°	Note 1
Contrast Ratio	C	$\theta = -5^\circ, \varnothing = 270^\circ$	2	3	-	Note 3
Response Time(rise)	t_r	$\theta = -5^\circ, \varnothing = 270^\circ$	-	170 ms	255 ms	Note 2
Response Time(fall)	t_f	$\theta = -5^\circ, \varnothing = 270^\circ$	-	350 ms	525 ms	Note 2

Note 1.

Optical characteristics-2

Viewing angle

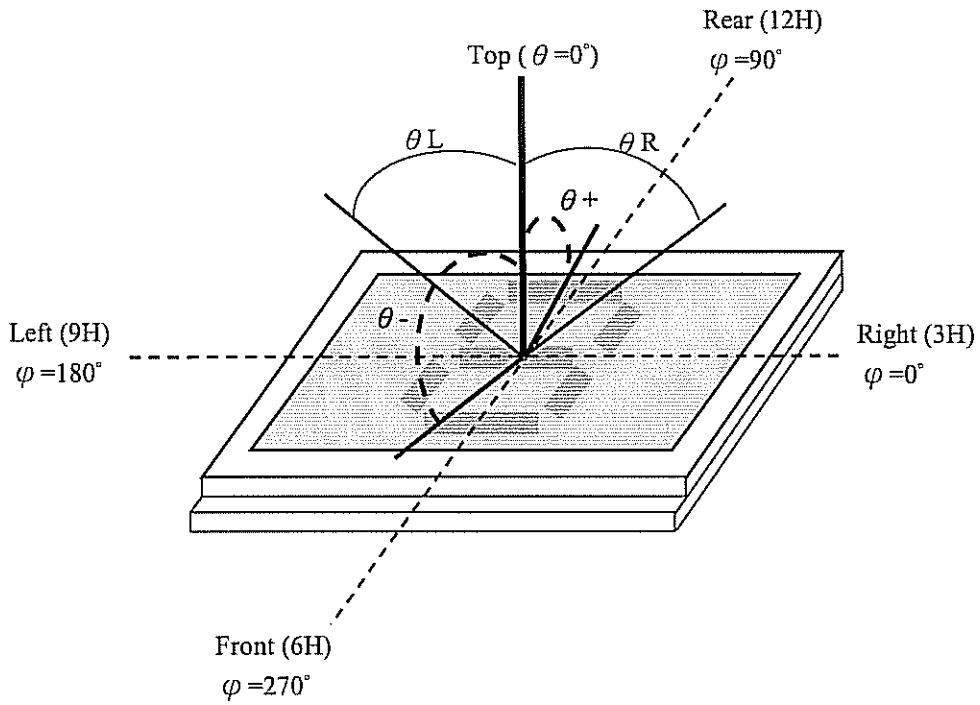

Viewing angle

Note 2.

Optical characteristics-3

Fig.2 Definition of response time

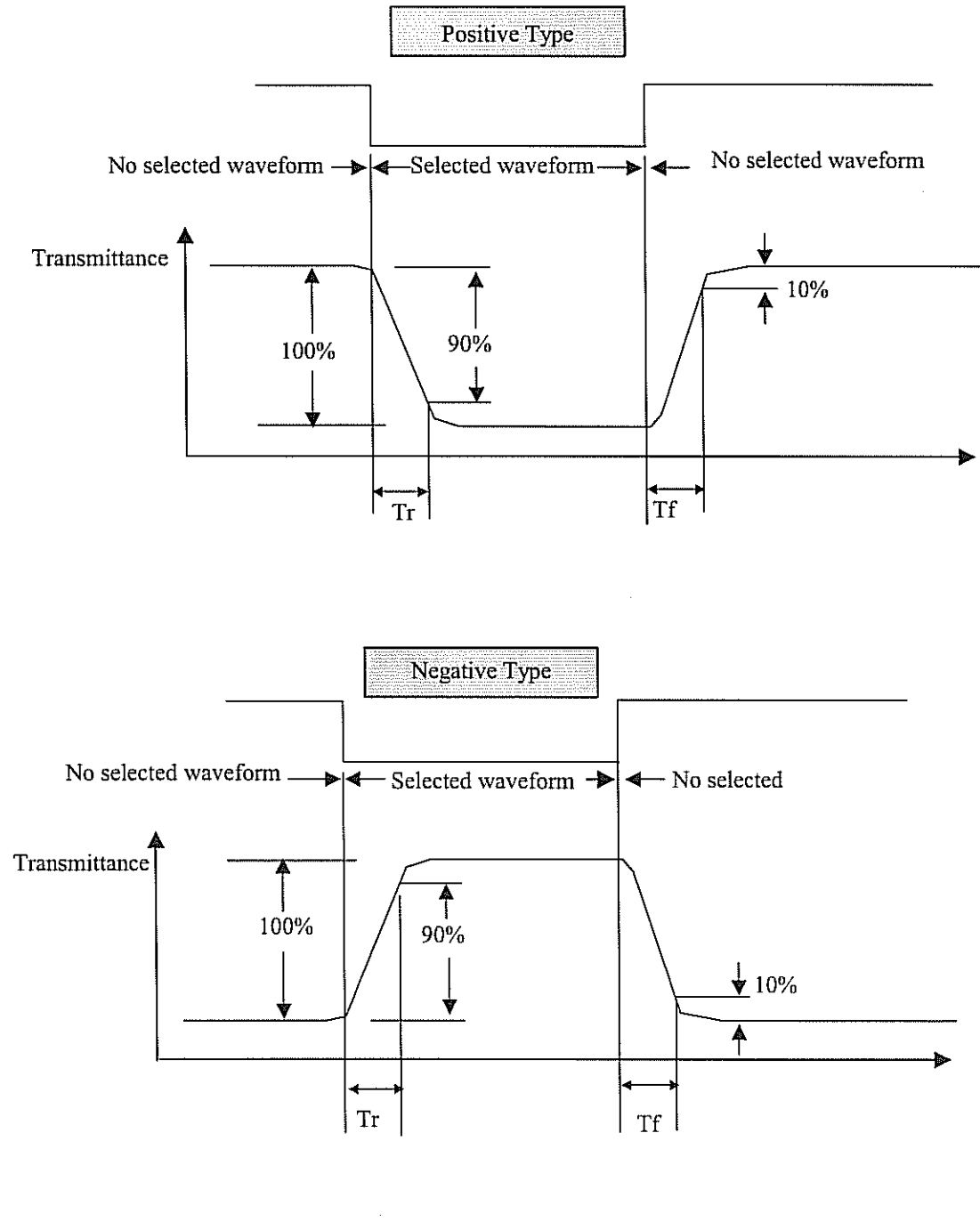

Electrical characteristics-2

※2 Drive waveform

V_{op} : Drive voltage f_F : Frame frequency

$1/B$: Bias f_D : Drive frequency

N: Duty

(1) Selected waveform

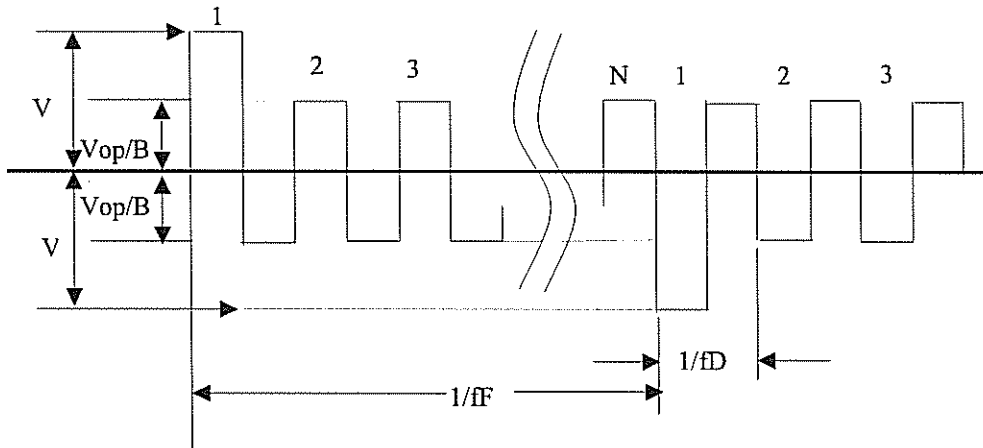

(2) Non- Selected waveform

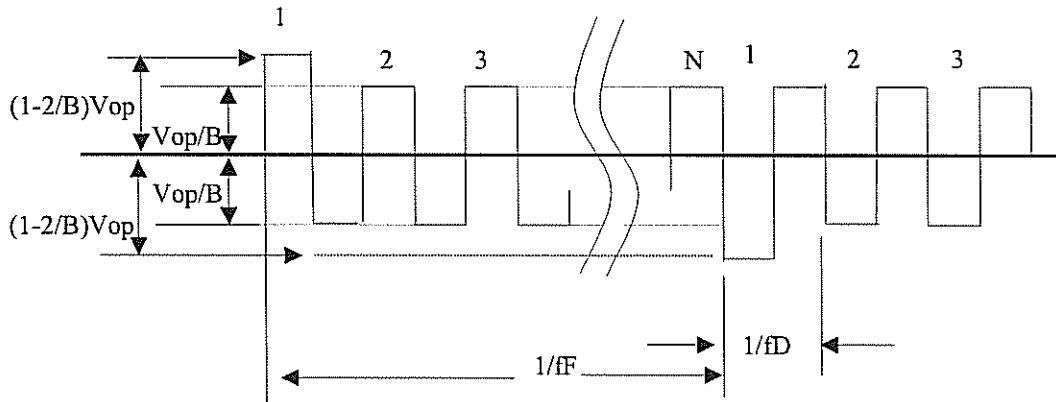

Note:

Frame frequency is defined as follows: Common side supply voltage peak - to - peak $/2 = 1$ period

1.6 Backlight Characteristics

LCD Module with LED backlight

Maximum Ratings

Item	Symbol	Conditions	Min.	Max.	Unit
Forward Current	IF	Ta =25°C	-	120	mA
Reverse Voltage	VR	Ta =25°C	-	5	V
Power Dissipation	PO	Ta =25°C	-	0.51	W

Electrical / Optical Characteristics

Item	Symbol	Conditions	Min.	Typ.	Max.	Unit
Forward Voltage	VF	IF= 120 mA	-	3.7	4.2	V
Reverse Current	IR	VR= 5 V	-	-	10	uA
Average Brightness	IV	IF=120 mA	15.0	30.0		cd/m ²
CIE Color Coordinate (With LCD)	X	IF= 120 mA	0.25	0.31	0.37	-
	Y		0.28	0.34	0.40	
Uniformity	ΔB	IvMin / IvMax *100%	70	-	-	%
Color	White					

*1 This value will be changed while mass production.

*2 : $\Delta B = B(\min) / B(\max)$

2. MODULE STRUCTURE

2.1 Counter Drawing

2.1.1 LCM Mechanical Diagram

* See Appendix

2.1.2 Block Diagram

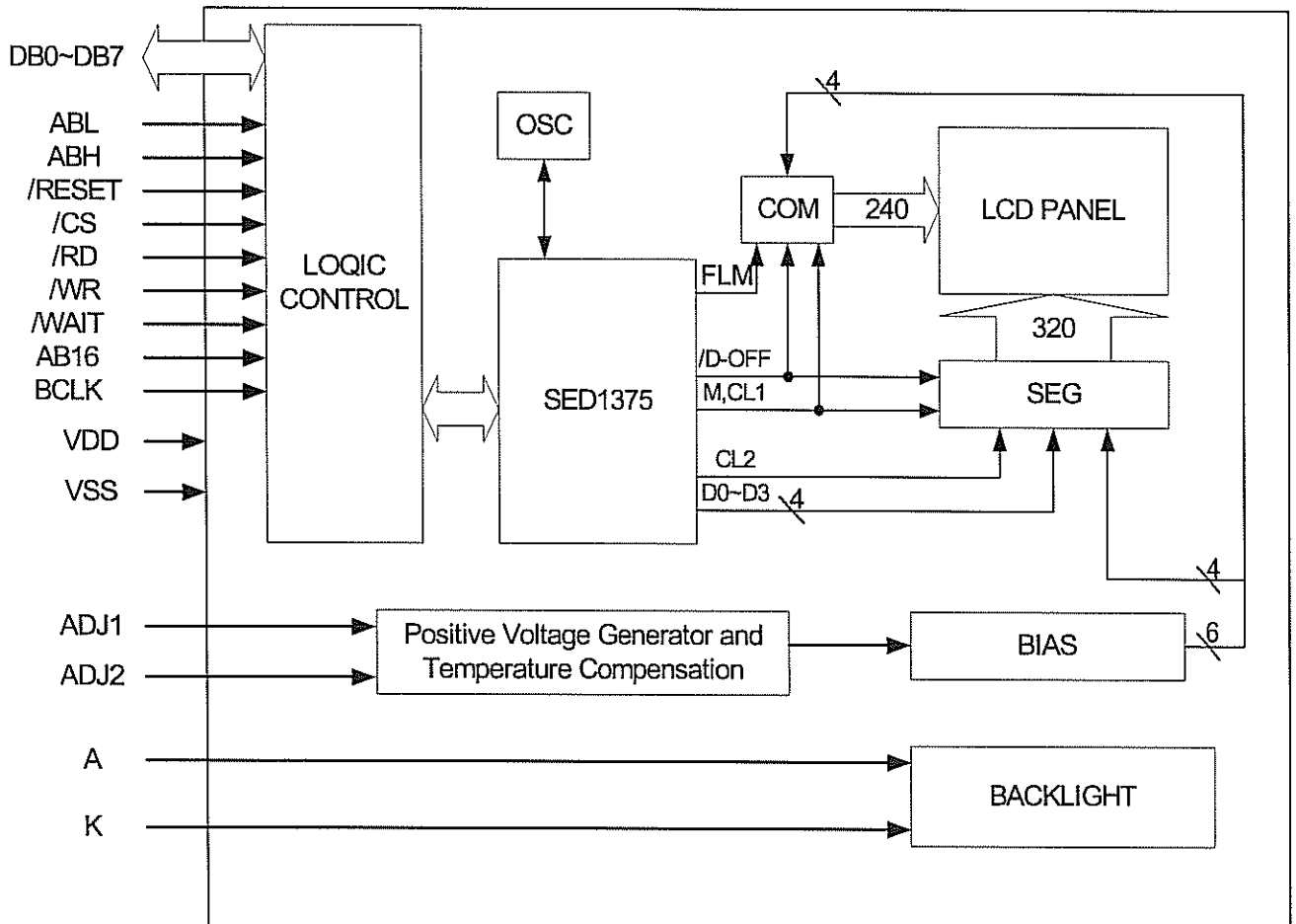

2.2 Interface Pin Description

Pin No.	Symbol	Function
1	V _{DD}	Power Supply for Logic (+3.3V)
2	V _{SS}	Signal Ground (GND)
3	Adj1	LCD Contrast Adjust Pin1
4	Adj2	LCD Contrast Adjust Pin2
5	DB0	Data bus 0
6	DB1	Data bus 1
7	DB2	Data bus 2
8	DB3	Data bus 3
9	DB4	Data bus 4
10	DB5	Data bus 5
11	DB6	Data bus 6
12	DB7	Data bus 7
13	ABL	Address Low Byte Latch Select
14	ABH	Address High Byte Latch Select
15	/RESET	Reset Control, Active "L"
16	/CS	Chip Select, Active "L"
17	/RD	Data Read (read data from the module at "L")
18	/WR	Data Write (write data to the module at "L")
19	/WAIT	Busy Status Output
20	AB16	Address 16 for SED1375
21	BCLK	System Bus Clock Input
22	NC	Not Connection
23	A	Power Supply for LED Backlight anode input
24	K	Power Supply for LED Backlight cathode input

• Contrast Adjust

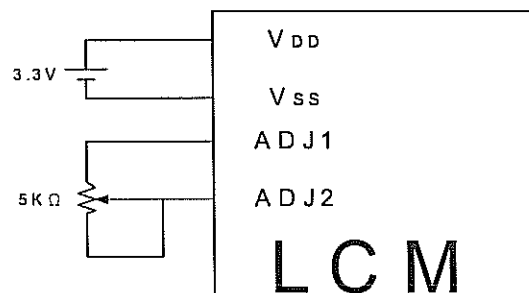

2.3 Timing Characteristics

Interface Timing

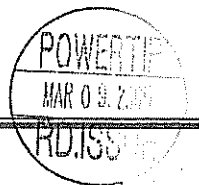
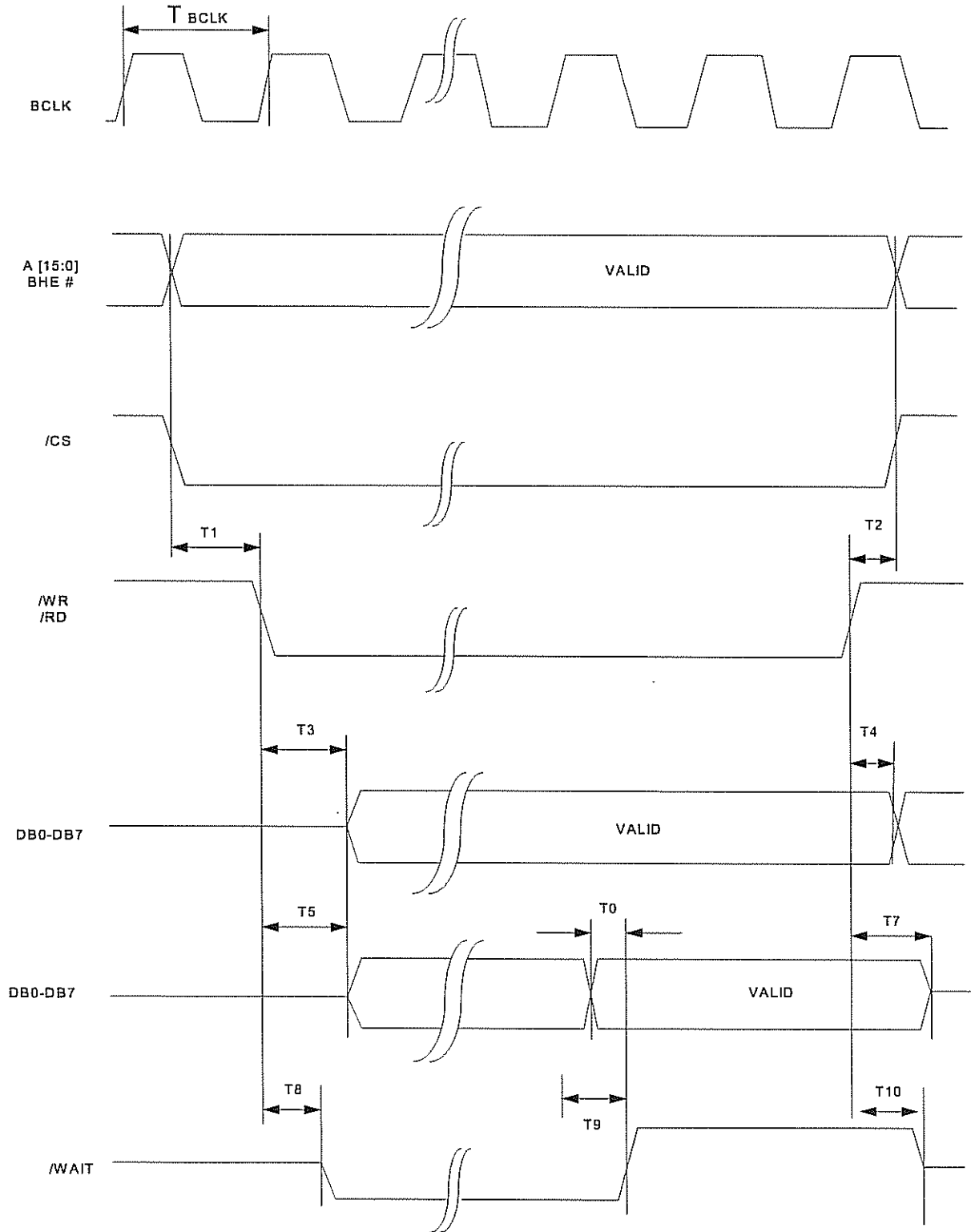

Symbol	Parameter	Min	Max	Unit
f _{BCLK}	Bus Clock frequency	0	50	MHz
T _{BCLK}	Bus Clock period	1/ f _{BCLK}	-	
t1	A[15:0], BHE#, CS# valid to WE#, RD# low	0	-	ns
t2	WE#, RD# high, to A[15:0], BHE#, CS# invalid	0	-	ns
t3	WE# low to D[15:0] valid (write cycle)	-	T _{BCLK}	ns
t4	WE# high to D[15:0] invalid (write cycle)	0	-	ns
t5	RD# low to D[15:0] driven (read cycle)	-	16	ns
t6	D[15:0] valid to WAIT# high (read cycle)	0	-	ns
t7	RD# high to D[15:0] high impedance (read cycle)	-	10	ns
t8	WE#, RD# low to WAIT# driven low	-	14	ns
t9	BCLK to WAIT# high	-	16	ns
t10	WE#, RD# high to WAIT# high impedance	-	11	ns

Clock Input Requirements

Clock input waveform

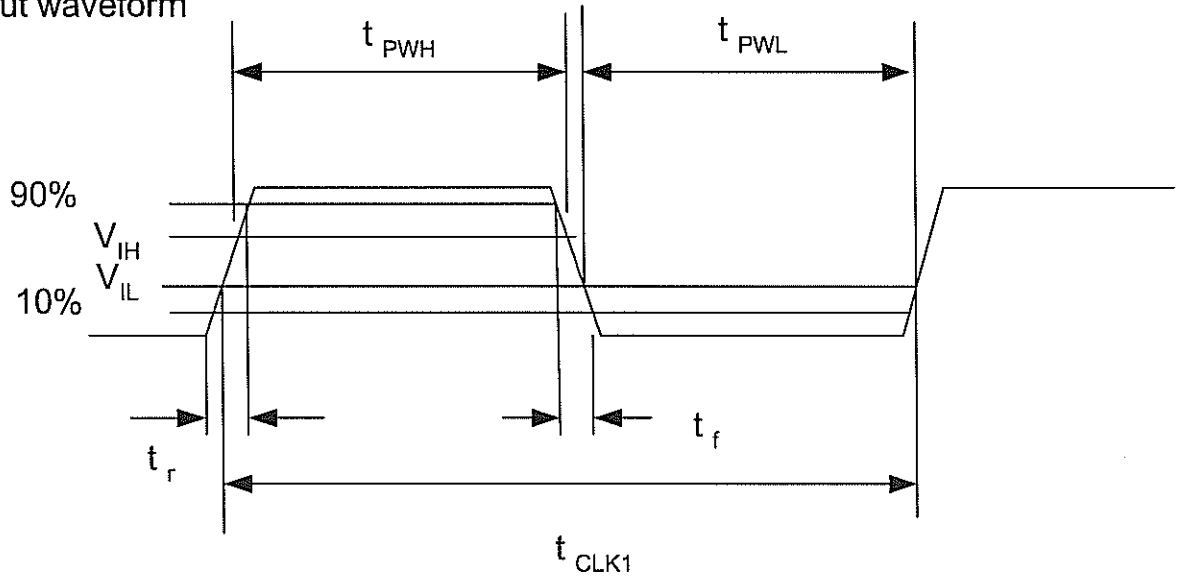

Symbol	Parameter	Min	Max	Unit
T _{CLKI}	Input Clock Period (CLKI)	20	-	ns
T _{PWH}	Input Clock Pulse Width High (CLKI)	9	-	ns
T _{PWL}	Input Clock Pulse Width Low (CLKI)	10	-	ns
t _f	Input Clock Fall Time (10%-90%)	-	5	ns
t _r	Input Clock Rise Time (10%-90%)	-	5	ns

Note: When CLKI is > 25MHz it must be divided by 2 (REG[02h] bit4=1).

Power On/Reset Timing

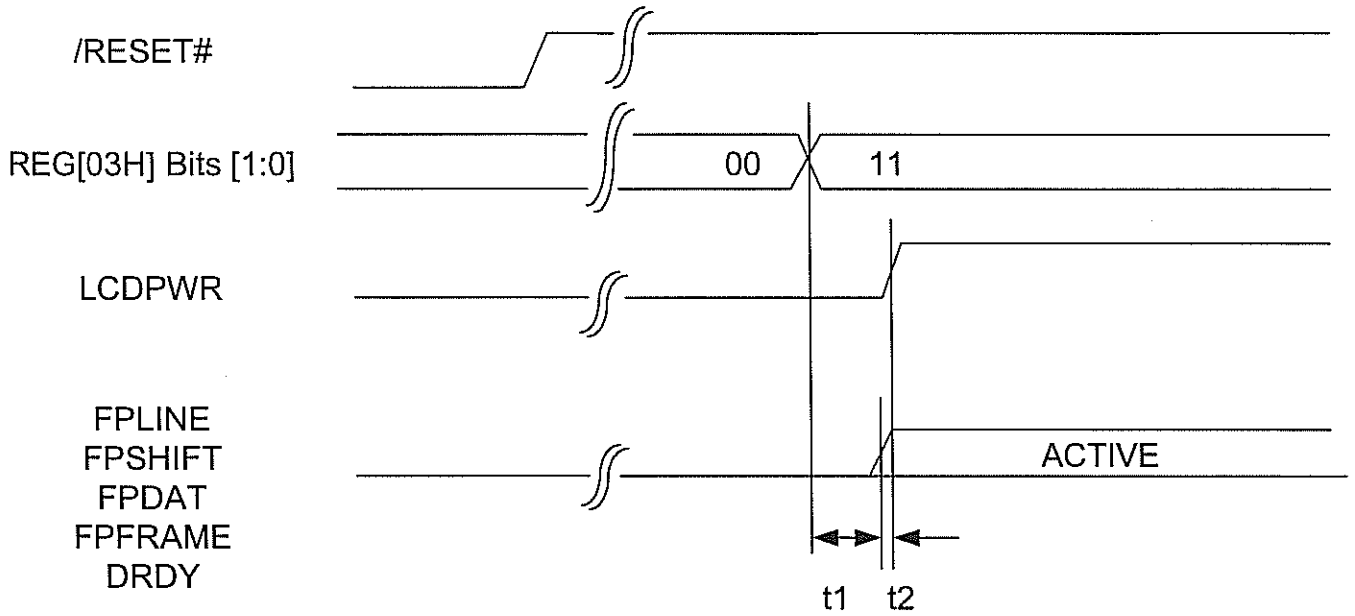

Symbol	Parameter	Min	Typ	Max	Unit
t ₁	Reg[03h] to FPLINE, FPFRAME, FPSHIFT, FPDAT, DRDY active	-	-	T _{FPFRAME}	ns
t ₂	FPLINE, FPFRAME, FPSHIFT, FPDAT, DRDY active to LCDPWR	-	0	-	Frames

Note: Where T_{FPFRAME} is the period of FPFRAME and T_{PCLK} is the period of the pixel clock.

Power Down/Up Timing

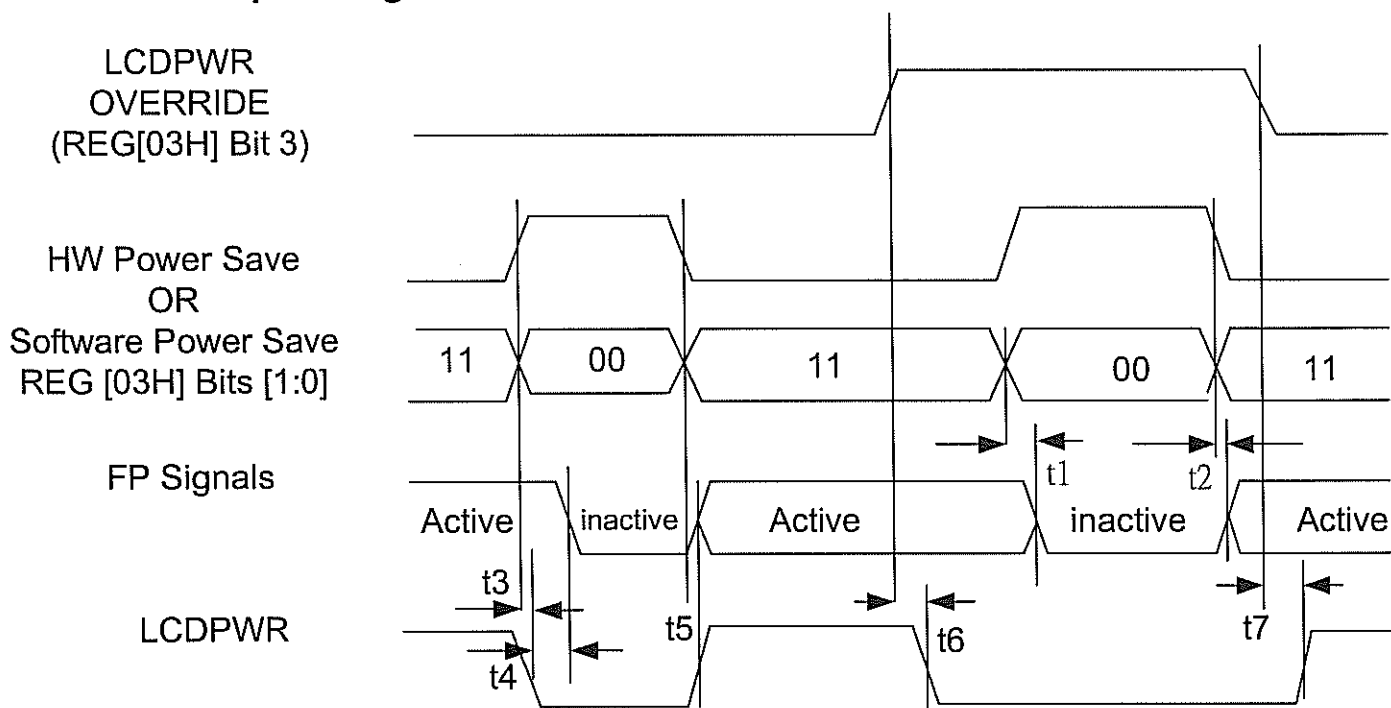

Symbol	Parameter	Min	Typ	Max	Unit
t1	HW Power Save active to FPLINE, PFRAME, FPSHIFT, FPDAT, DRDY inactive – LCDPWR Override=1	-	-	1	Frames
t2	HW Power Save inactive to FPLINE, PFRAME, FPSHIFT, FPDAT, DRDY active – LCDPWR Override=1	-	-	1	Frames
t3	HW Power Save active to FPLINE, PFRAME, FPSHIFT, FPDAT, DRDY inactive – LCDPWR Override=0	-	-	1	Frames
t4	LCDPWR low to FPLINE, PFRAME, FPSHIFT, FPDAT, DRDY inactive – LCDPWR Override=0	-	-	1	Frames
t5	HW Power Save inactive to FPLINE, PFRAME, FPSHIFT, FPDAT, DRDY active – LCDPWR Override=0	-	-	1	Frames
t6	LCDPWR Override active (1) to LCDPWR inactive	-	127	-	Frames
t7	LCDPWR Override inactive (1) to LCDPWR active	-	0	-	Frames



3. QUALITY ASSURANCE SYSTEM

3.1 Quality Assurance Flow Chart

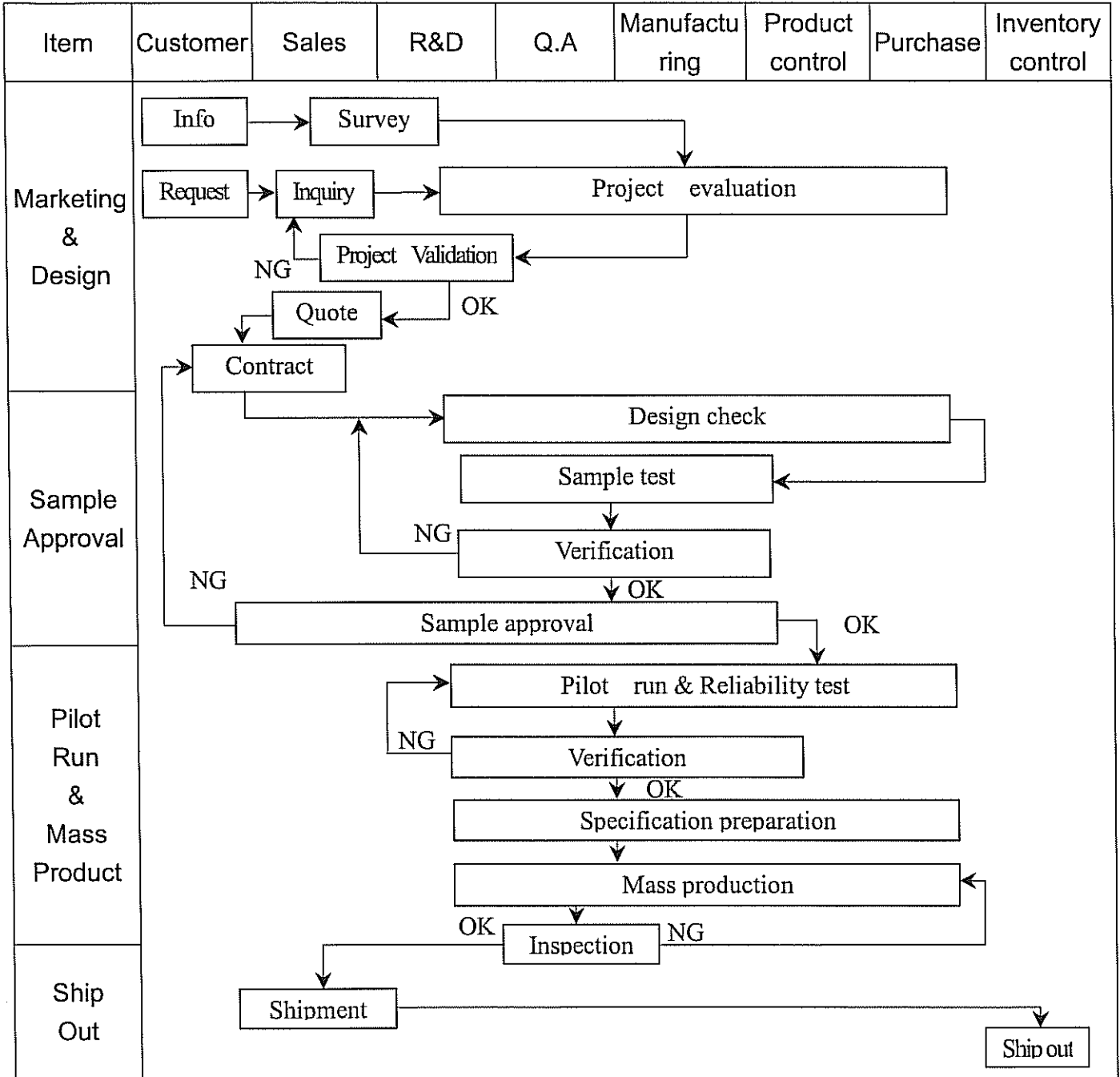

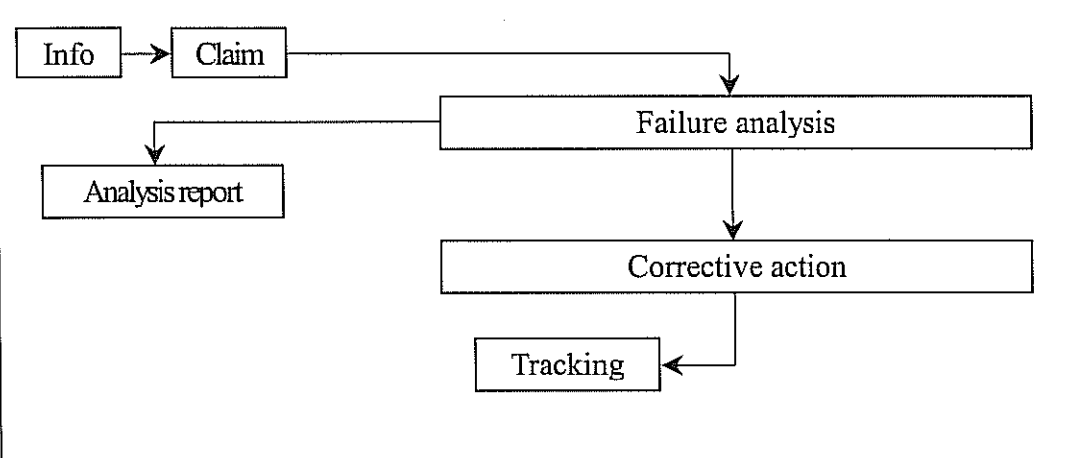
Item	Customer	Sales	R&D	Q.A	Manufacturing	Product control	Purchase	Inventory control
Sales Service	 <pre> graph TD Info[Info] --> Claim[Claim] Claim --> Failure[Failure analysis] Failure --> Report[Analysis report] Failure --> Action[Corrective action] Action --> Tracking[Tracking] </pre>							
Q.A Activity	1. ISO 9001 Maintenance Activities 3. Equipment calibration 5. Standardization Management				2. Process improvement proposal 4. Education And Training Activities			



3.2 Inspection Specification

Inspection Standard : MIL-STD-105E Table Normal Inspection Single Sampling Level II

Equipment : Gauge , MIL-STD , Powertip Tester , Sample

IQC Defect Level : Major Defect AQL 0.4; Minor Defect AQL 1.5

FQC Defect Level : 100% Inspection

OUT Going Defect Level : Sampling

Specification :

NO	Item	Specification	Judge	Level
1	Part Number	The part number is inconsistent with work order of production	N.G.	Major
2	Quantity	The quantity is inconsistent with work order of production	N.G.	Major
3	Electronic characteristics of LCM A=(L + W) 2	The display lacks of some patterns.	N.G.	Major
		Missing line.	N.G.	Major
		The size of missing dot, A is > 1/2 Dot size	N.G.	Major
		There is no function.	N.G.	Major
		Output data is error	N.G.	Major
4	Appearance of LCD A=(L + W) 2	Material is different with work order of production	N.G.	Major
		LCD is assembled in inverse direction	N.G.	Major
		Bezel is assembled in inverse direction	N.G.	Major
		Shadow is within LCD viewing area + 0.5 mm	N.G.	Major
		The diameter of dirty particle, A is > 0.4 mm	N.G.	Minor
	Dirty particle (Including scratch 、 bubble)	Dirty particle length is > 3.0mm, and 0.01mm < width ≤0.05mm	N.G.	Minor
		Display is without protective film	N.G.	Minor
		Conductive rubber is over bezel 1mm	N.G.	Minor
		Polarizer exceeds over viewing area of LCD	N.G.	Minor
		Area of bubble in polarizer, A > 1.0mm, the number of bubble is > 1 piece.	N.G.	Minor
		0.4mm < Area of bubble in polarizer, A < 1.0mm, the number of bubble is > 4 pieces.	N.G.	Minor
5	Appearance of PCB A=(L + W) 2	Burned area or wrong part number is on PCB	N.G.	Major
		The symbol, character, and mark of PCB are unidentifiable.	N.G.	Minor
		The stripped solder mask , A is > 1.0mm	N.G.	Minor
		0.3mm < stripped solder mask or visible circuit, A < 1.0mm, and the number is ≥4 pieces	N.G.	Minor
		There is particle between the circuits in solder mask	N.G.	Minor
		The circuit is peeled off or cracked	N.G.	Minor
		There is any circuits risen or exposed.	N.G.	Minor
		0.2mm < Area of solder ball, A is ≤0.4mm	N.G.	Minor
		The number of solder ball is ≥3 pieces	N.G.	Minor
The magnitude of solder ball, A is > 0.4mm.	N.G.	Minor		

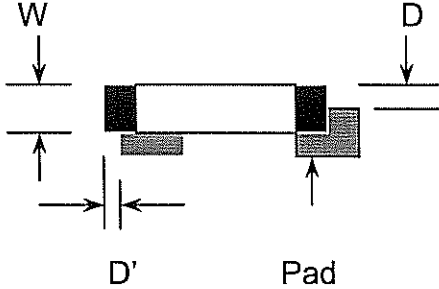
NO	Item	Specification	Judge	Level
6	Appearance of molding $A=(L+W) \cdot 2$	The shape of modeling is deformed by touching.	N.G.	Major
		Insufficient epoxy: Circuit or pad of IC is visible	N.G.	Minor
		Excessive epoxy: Diameter of modeling is $> 20\text{mm}$ or height is $> 2.5\text{mm}$	N.G.	Minor
		The diameter of pinhole in modeling, A is $> 0.2\text{mm}$.	N.G.	Minor
7	Appearance of frame $A=(L+W) \cdot 2$	The folding angle of frame must be $> 45^\circ + 10^\circ$	N.G.	Minor
		The area of stripped electroplate in top-view of frame, A is $> 1.0\text{mm}$.	N.G.	Minor
		Rust or crack is (Top view only)	N.G.	Minor
		The scratched width of frame is $> 0.06\text{mm}$. (Top view only)	N.G.	Minor
8	Electrical characteristic of backlight $A=(L+W) \cdot 2$	The color of backlight is nonconforming	N.G.	Major
		Backlight can't work normally.	N.G.	Major
		The LED lamp can't work normally	N.G.	Major
		The unsoldering area of pin for backlight, A is $> 1/2$ solder joint area.	N.G.	Minor
		The height of solder pin for backlight is $> 2.0\text{mm}$	N.G.	Minor
10	Assembly parts $A=(L+W) \cdot 2$	The mark or polarity of component is unidentifiable.	N.G.	Minor
		The height between bottom of component and surface of the PCB is floating $> 0.7\text{mm}$	N.G.	Minor
		$D > 1/4W$ 	N.G.	Minor
		End solder joint width, D' is $> 50\%$ width of component termination or width of pad	N.G.	Minor
		Side overhang, D is $> 25\%$ width of component termination.	N.G.	Minor
		Component is cracked, deformed, and burned, etc.	N.G.	Minor
		The polarity of component is placed in inverse direction.	N.G.	Minor
		Maximum fillet height of solder extends onto the component body or minimum fillet height is $< 0.5\text{mm}$.	N.G.	Minor

5. PRECAUTION RELATING PRODUCT HANDLING

5.1 SAFETY

- 5.1.1 If the LCD panel breaks , be careful not to get the liquid crystal to touch your skin.
- 5.1.2 If the liquid crystal touches your skin or clothes , please wash it off immediately by using soap and water.

5.2 HANDLING

- 5.2.1 Avoid any strong mechanical shock which can break the glass.
- 5.2.2 Avoid static electricity which can damage the CMOS LSI—When working with the module , be sure to ground your body and any electrical equipment you may be using.
- 5.2.3 Do not remove the panel or frame from the module.
- 5.2.4 The polarizing plate of the display is very fragile. So , please handle it very carefully, do not touch , push or rub the exposed polarizing with anything harder than an HB pencil lead (glass , tweezers , etc.)
- 5.2.5 Do not wipe the polarizing plate with a dry cloth , as it may easily scratch the surface of plate.
- 5.2.6 Do not touch the display area with bare hands , this will stain the display area.
- 5.2.7 Do not use ketonics solvent & aromatic solvent. Use with a soft cloth soaked with a cleaning naphtha solvent.
- 5.2.8 To control temperature and time of soldering is $280 \pm 10^{\circ}\text{C}$ and 3-5 sec.
- 5.2.9 To avoid liquid (include organic solvent) stained on LCM

5.3 STORAGE

- 5.3.1 Store the panel or module in a dark place where the temperature is $25^{\circ}\text{C} \pm 5^{\circ}\text{C}$ and the humidity is below 65% RH.
- 5.3.2 Do not place the module near organics solvents or corrosive gases.
- 5.3.3 Do not crush , shake , or jolt the module.

5.4 TERMS OF WARRANTY

5.4.1 Applicable warrant period

The period is within thirteen months since the date of shipping out under normal using and storage conditions.

5.4.2 Unaccepted responsibility

This product has been manufactured to your company's specification as a part for use in your company's general electronic products. It is guaranteed to perform according to delivery specifications. For any other use apart from general electronic equipment, we cannot take responsibility if the product is used in nuclear power control equipment, aerospace equipment , fire and security systems or any other applications in which there is a direct risk to human life and where extremely high levels of reliability are required.

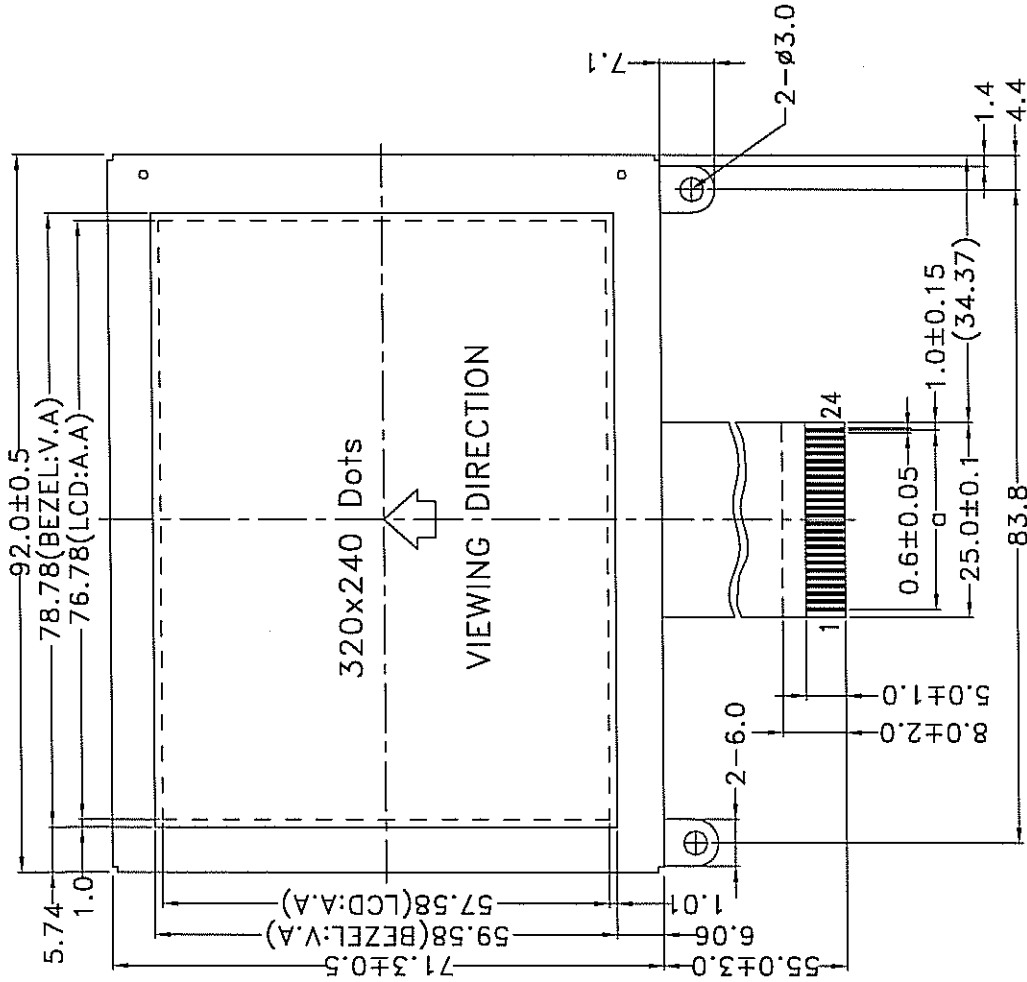

7.9Max
5.4±0.5

5.4
STIFFENER
0.3±0.05

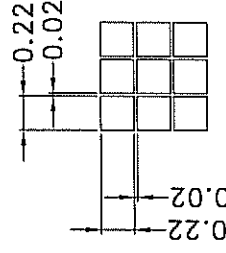

DOTS DETAIL
SCALE 20/1

- NOTE:
- 1.a=P1.0x23=23.0±0.1
 - 2.The tolerance unless classified ±0.3mm
 - 3.LCD type : FSTN
 - 4.LCD mode : Positive / Transflective
 - 5.T_{op}: -20°C~70°C , T_{st}: -30°C~80°C
 - 6.Viewing Drection : 6 O'clock



久正光電股份有限公司 POWERTIP TECHNOLOGY CORPORATION		APPROVED	CHECKER	DRAWN
	SCALE:1/1	UNIT:mm	PAGE:1/1	
圖面名稱	PS320240WRF-JE8H04			
圖面編號	PG-03105-006	EDI	0	

REV	DESCRIPTION	DATE

LCM Model PS320240WRF-JE8H04

LCM包裝規格書

LCM Packaging Specifications

Approve	Check	Contact
圖-3.9	圖-2.18	圖-2.18
DATE	初版	版次 Ver
05'02.18	05'02.18	0

1. 包裝材料規格表 (Packaging Material) : (per carton)

No.	Item	Model	Dimensions (mm)	Quantity
1	成品 (LCM)	PS320240WRF-JE8H04	92.0 X 71.3	60
2	靜電袋(1)	BAG150120ARA0A	150 X 120	60
3	氣泡袋(2)	BAG170150AWB0A	170 X 150	60
4	A3隔板(3)	BX24500045BN0A	245 X 45 X 2.5	78
5	B3隔板(4)	BX29300045BL0A	293 X 45 X 2.5	12
6	海綿墊(5)	OTFOAM00006A0A	290 X 240 X 10	12
7	C3內盒(6)Product Box	BX31025510AA0A	310 X 255 X 100	6
8	外紙箱(7)Carton	BX52732536CC0A	527 X 325 X 360	1
9				

2. 單箱數量規格表 (Packaging Specifications and Quantity) :

(1)Quantity Of Spacer : A3隔板 X 13 , B3隔板 X 2

(1)Total LCM quantity in carton : no of boxes 6 x quantity per box 10 = 60

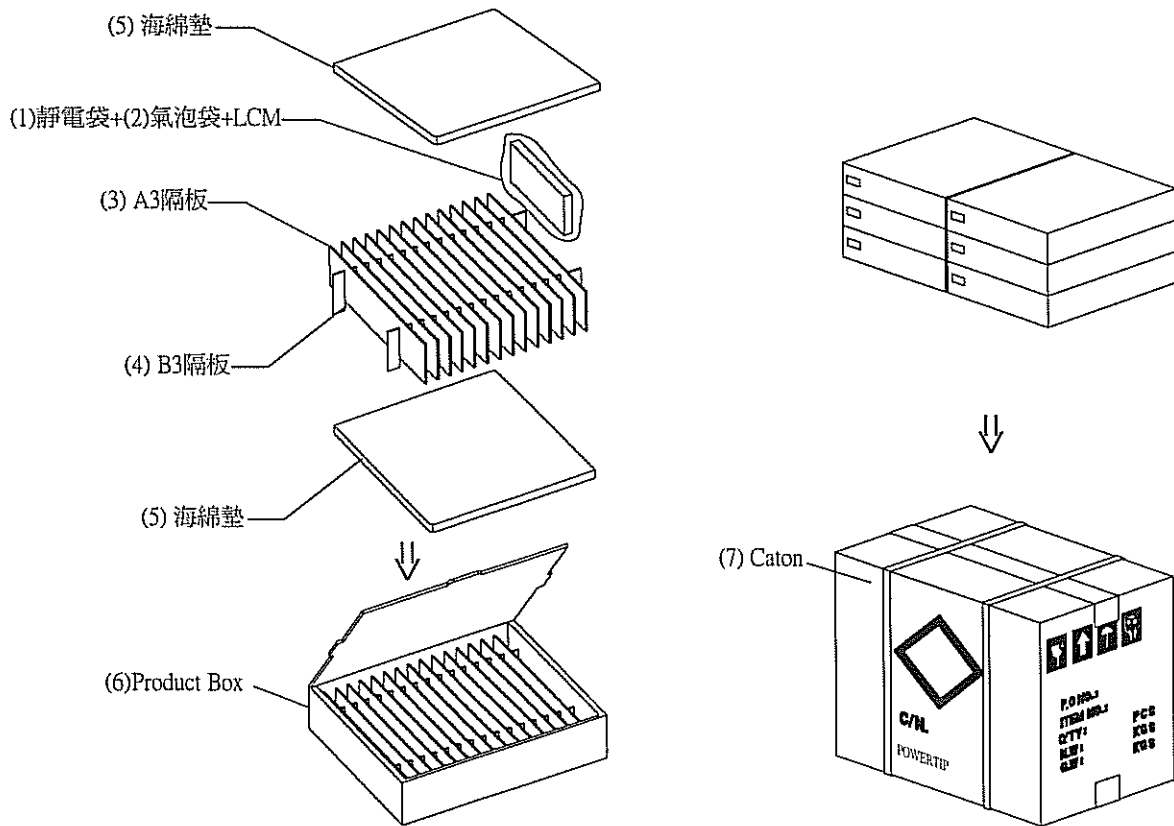

特記事項 (REMARK)

1. Label Specifications :

MODEL:
LOT NO:
QUANTITY:
CHECK:

1. 每放兩片模組空一格放置格
。(如放置格示意圖)

放置格示意圖:

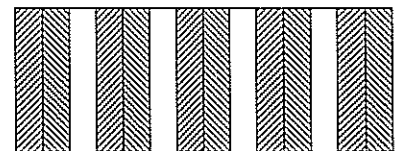

1. 模組 2. 空格

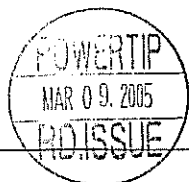

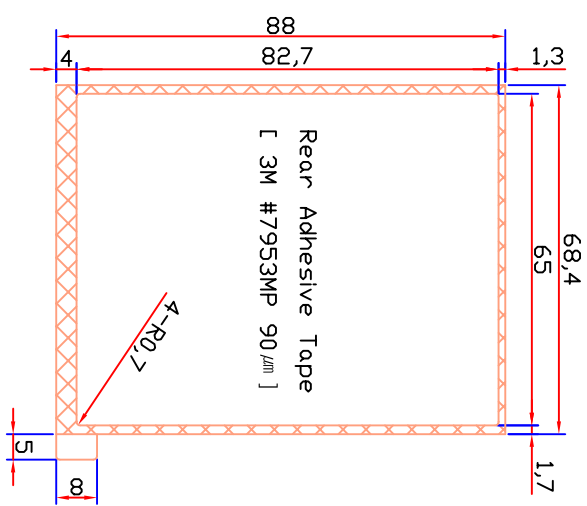
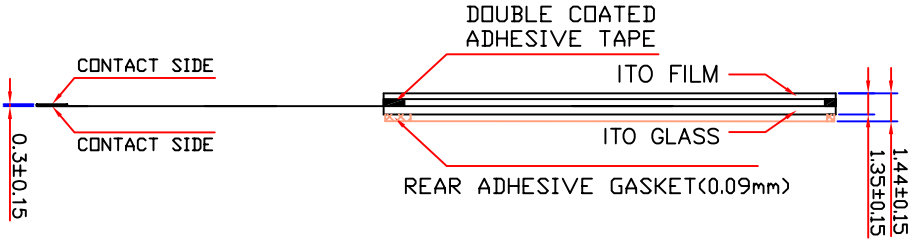
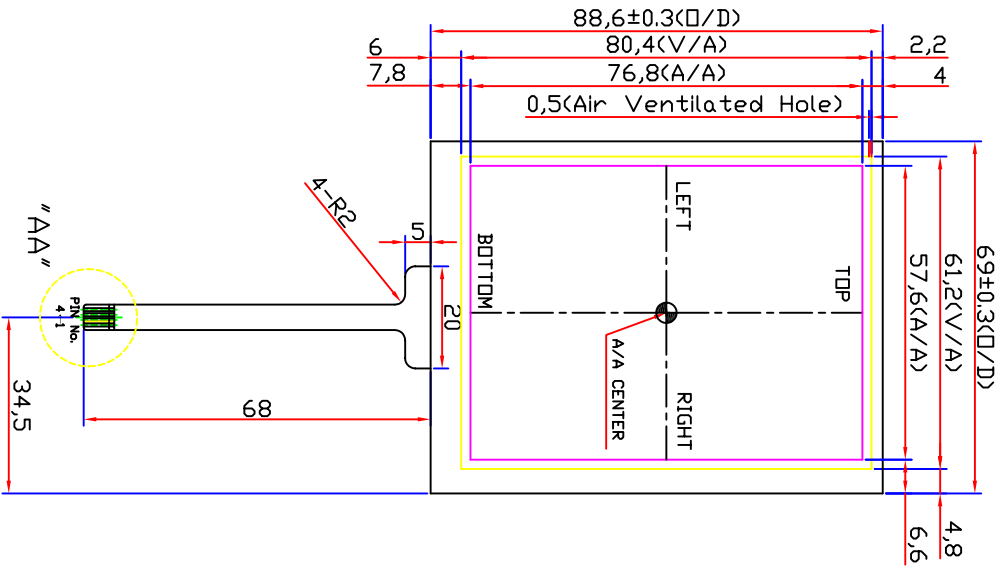

REMARK

1. Glass Thk: 1.1mm
2. Film Type: Non-Glare
3. Total Thk: 1.44±0.15mm (Including Rear Adhesive Tape)
4. Linearity: ±1.5% or less
5. Transmittance: 80% or more
6. Resistance
200 < Y < 900 ohm
200 < X < 900 ohm
7. Connector: FPC
8. General Tolerance: ±0.3

CIRCUIT DIAGRAM

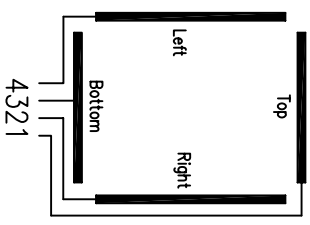

SIGNAL ASSIGNMENT

Pin No	Signal
1	Top
2	Right
3	Bottom
4	Left

Detail "AA" (Scale=4/1)

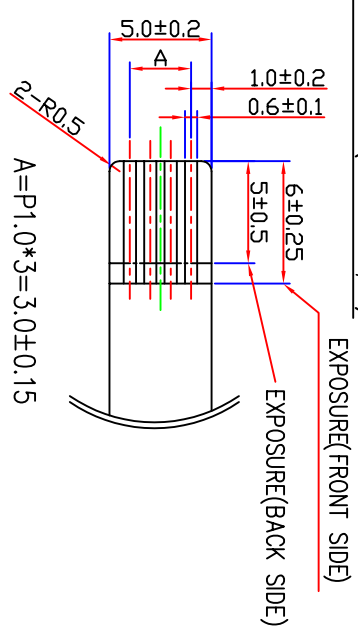

REV.No	REVISION	DATE	DRAWN	CHECKED
1	Changed Model Name	08.02.18	H. Y. IM	Y. J. OH
0	NEW DRAW	06.03.29	H. Y. IM	J. H. LEE, W. AN

DESIGN	DESCRIPTION	SHEET
	3.8" TOUCH PANEL	1/1