

SPECIFICATIONS

CUSTOMER	:	CKR048
SAMPLE CODE	:	SC1602LRS-KWA-HY8Q
MASS PRODUCTION CODE	:	PC1602LRS-KWA-HY8Q
SAMPLE VERSION	:	01
SPECIFICATIONS EDITION	:	001
DRAWING NO. (Ver.)	:	JLMD - PC1602LRS-KWA-HY8Q (Ver.001)
PACKAGING NO. (Ver.)	:	JPKG - PC1602LRS-KWA-HY8Q (Ver.001)

Customer Approved

Date:

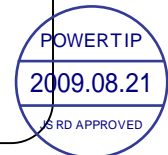

Approved	Checked	Designer
閔偉 魏永超 Ryan Yan Wesley Wei	張平 Ping Zhang	李德軍 Raymond Lee

- Preliminary specification for design input
- Specification for sample approval

POWERTIP TECH. CORP.

Headquarters: No.8, 6 th Road, Taichung Industrial Park, Taichung, Taiwan 台中市 407 工業區六路 8 號	TEL: 886-4-2355-8168 FAX: 886-4-2355-8166	E-mail: sales@powertip.com.tw Http://www.powertip.com.tw
---	--	---

Contents

1. SPECIFICATIONS

- 1.1 Features
- 1.2 Mechanical Specifications
- 1.3 Absolute Maximum Ratings
- 1.4 DC Electrical Characteristics
- 1.5 Optical Characteristics
- 1.6 Backlight Characteristics

2. MODULE STRUCTURE

- 2.1 Counter Drawing
- 2.2 Interface Pin Description
- 2.3 Timing Characteristics
- 2.4 Character Pattern

3. QUALITY ASSURANCE SYSTEM

- 3.1 Quality Assurance Flow Chart
- 3.2 Inspection Specification

4. RELIABILITY TEST

- 4.1 Reliability Test Condition

5. PRECAUTION RELATING PRODUCT HANDLING

- 5.1 Safety
- 5.2 Handling
- 5.3 Storage
- 5.4 Terms of Warranty

- Appendix:
- 1. LCM Drawing
 - 2. Packaging

1. SPECIFICATIONS

1.1 Features

Item	Standard Value
Display Type	16* 2 Characters
LCD Type	STN,Gray, Transflective, Positive.
Driver Condition	LCD Module : 1/16 Duty , 1/5 Bias
Viewing Direction	6 O'clock
Backlight	Yellow green LED B/L
Weight	11.6g
Interface	8 bit
Other(controller / driver IC)	ST7066U-0A
ROHS	THIS PRODUCT CONFORMS THE ROHS OF PTC Detail information please refer web side : http://www.powertip.com.tw/news/LatestNews.asp

1.2 Mechanical Specifications

Item	Standard Value	Unit
Outline Dimension	53.0 (L) *20.0 (W) * 8.1(H)	mm
Viewing Area	36.0(L) *10.0 (W)	mm
Active Area	34.1 (L) *7.4 (W)	mm
Character Size	1.85 (L)* 3.15(W)	mm
Character Pitch	2.15 (L)* 4.25(W)	mm

Note : For detailed information please refer to LCM drawing

1.3 Absolute Maximum Ratings

Item	Symbol	Condition	Min.	Max.	Unit
Power Supply Voltage	V _{DD}	—	-0.3	7.0	V
LCD driver Voltage	V _{LCD}	—	V _{DD} -10	V _{DD} +0.3	V
Input Voltage	V _{IN}	—	-0.3	V _{DD} +0.3	
Operating Temperature	T _{OP}	—	-20	70	°C
Storage Temperature	T _{ST}	Excluded B/L	-30	80	°C
Storage Humidity	H _D	Ta < 40°C	-	90	%RH

1.4 DC Electrical Characteristics

$V_{DD}=5.0\text{ V} \pm 10\%$, $V_{SS} = 0\text{V}$, $T_a = 25^\circ\text{C}$

Item	Symbol	Condition	Min.	Typ.	Max.	Unit
Logic Supply Voltage	V_{DD}	-	4.5	5.0	5.5	V
“H” Input Voltage	V_{IH}	-	$0.7V_{DD}$	-	V_{DD}	V
“L” Input Voltage	V_{IL}	-	-0.3	-	0.6	V
“H” Output Voltage	V_{OH}	$I_{OH}=-0.1\text{mA}$	3.9	-	V_{DD}	V
“L” Output Voltage	V_{OL}	$I_{OL}=0.1\text{mA}$	-	-	0.4	V
Supply Current	I_{DD}	$V_{DD}=5.0\text{V}; V_{OP}= 4.67\text{V};$ Pattern= Horizontal line*1	-	1.3	3	mA
LCM Driver Voltage	V_{OP}^*2	-20°C	4.67	4.87	5.07	V
		25°C	4.47	4.67	4.87	
		70°C	4.27	4.47	4.67	

NOTE: *1 The Maximum current display;

*2 The VOP test point is $V_{DD}-V_{O}$.

1.5 Optical Characteristics

LCD Panel : 1/16Duty , 1/4Bias , $V_{LCD} = 4.67 \text{ V}$, $T_a = 25^\circ\text{C}$

Item		Symbol	Conditions	Min.	Typ.	Max.	Unit	Reference	
Response Time	Rise	tr	$C \geq 2.0$, $\varnothing = 270^\circ$	-	80	120	ms	Note2	
	Fall	tf		-	150	225			
Viewing angle range	Top	$\Theta Y+$		-	40	-	Deg.	Notes 1	
	Bottom	$\Theta Y-$		-	40	-			
	Left	$\Theta X-$		-	35	-			
	Right	$\Theta X+$		-	35	-			
Contrast Ratio		CR		25°C	1	2	-	-	Note 3
Wavelength		Hue		-	565	570	575	nm	Note 4
Uniformity *1		ΔB	-	70	-	-	%		

Note 4 :

1 : $\Delta B = B(\text{min}) / B(\text{max}) * 100\%$

2 : Measurement Condition for Optical Characteristics:

- a : Environment: $25^\circ\text{C} \pm 5^\circ\text{C}$ / $60 \pm 20\%$ R.H , no wind , dark room below 10 Lux at typical lamp current and typical operating frequency.
- b : Measurement Distance: 500 ± 50 mm , ($\theta = 0^\circ$)
- c : Equipment: TOPCON BM-7 fast , (field 1°) , after 10 minutes operation.
- d : The uncertainty of the C.I.E coordinate measurement ± 0.01 , Average Brightness $\pm 4\%$

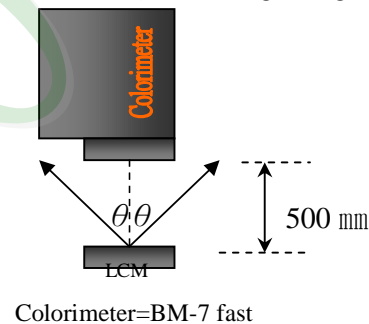

Note 1.

Optical characteristics-2

Viewing angle

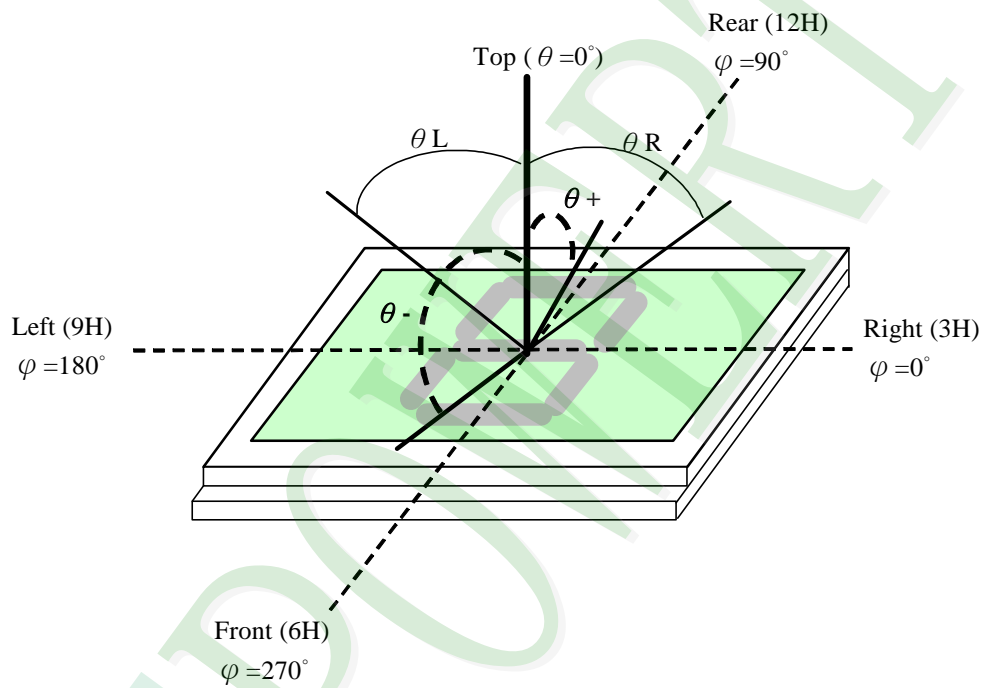

Viewing angle

Note 2.

Optical characteristics-3

Fig.2 Definition of response time

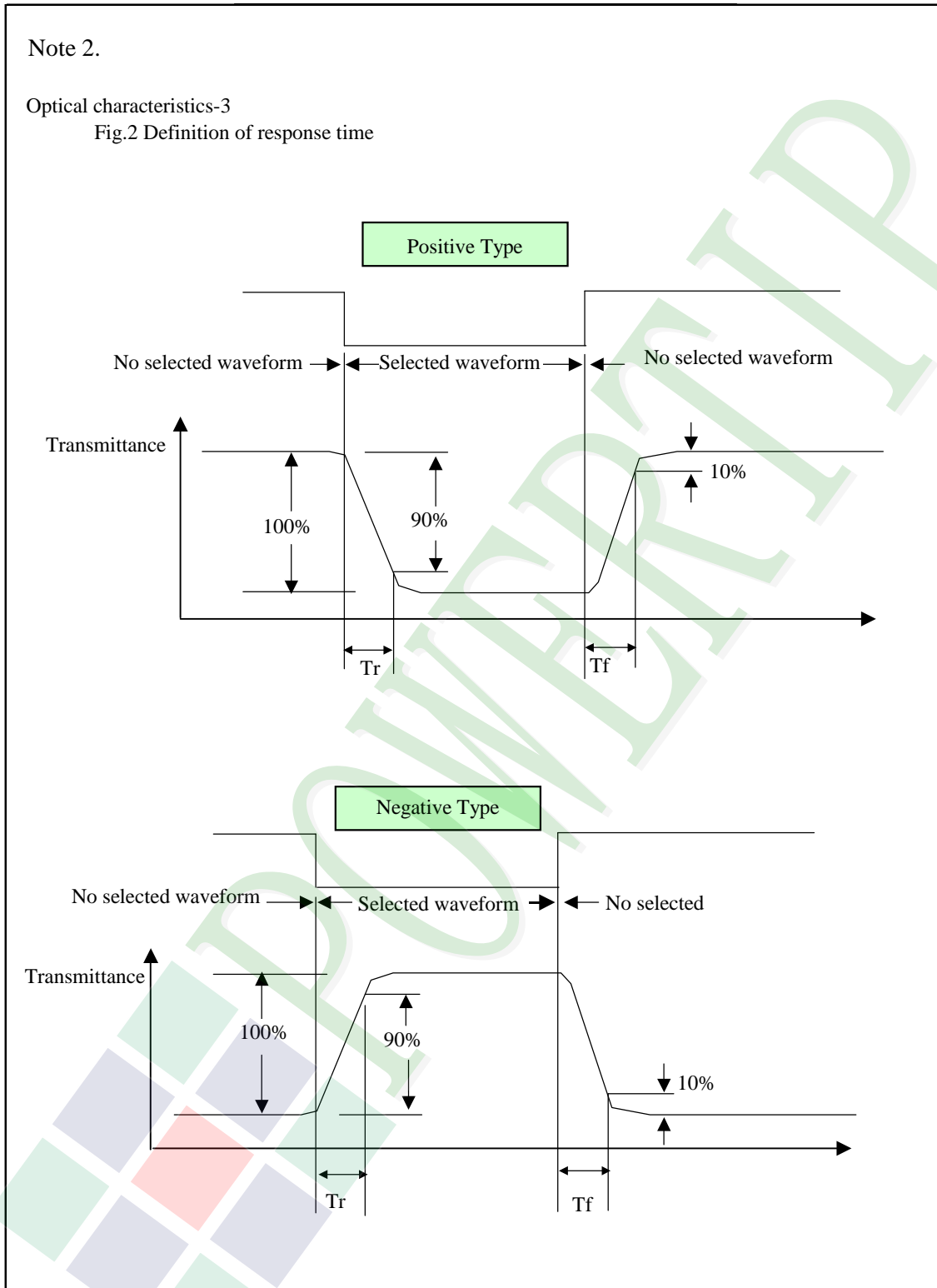

Electrical characteristics-2

※2 Drive waveform

V_{op} : Drive voltage

$1/B$: Bias

N : Duty

f_F : Frame frequency

f_D : Drive frequency

(1) Selected waveform

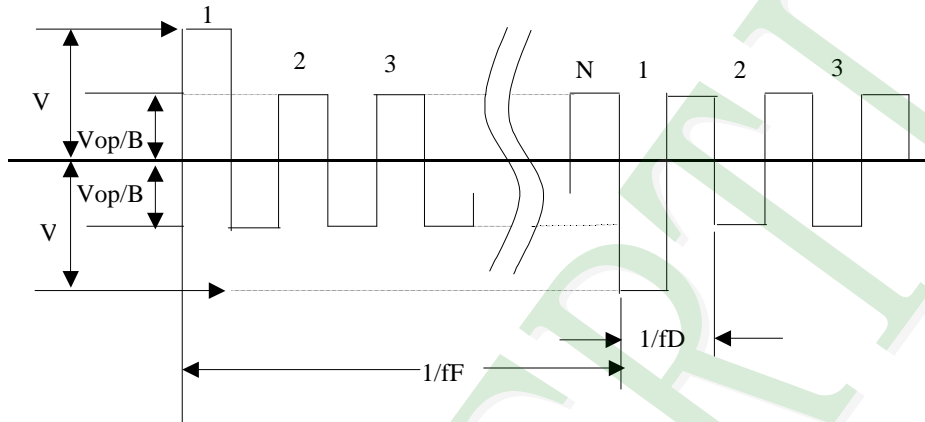

(2) Non- Selected wave form

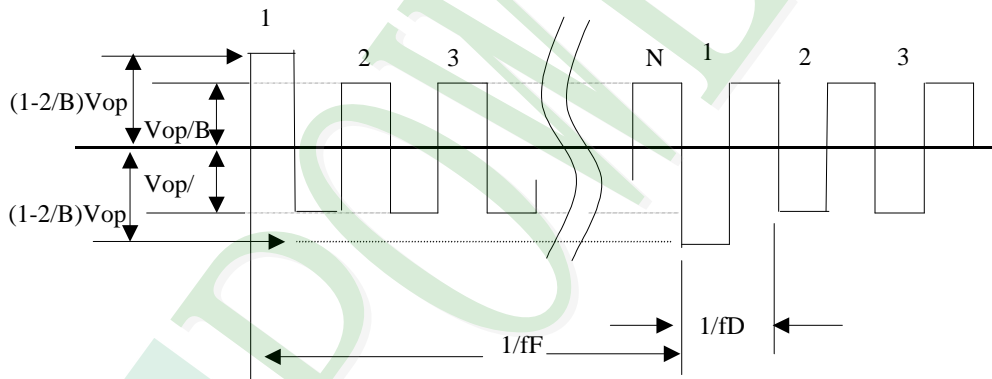

Note:

Frame frequency is defined as follows: Common side supply voltage peak - to - peak / 2 = 1 period

Note 3. : Definition of Vth

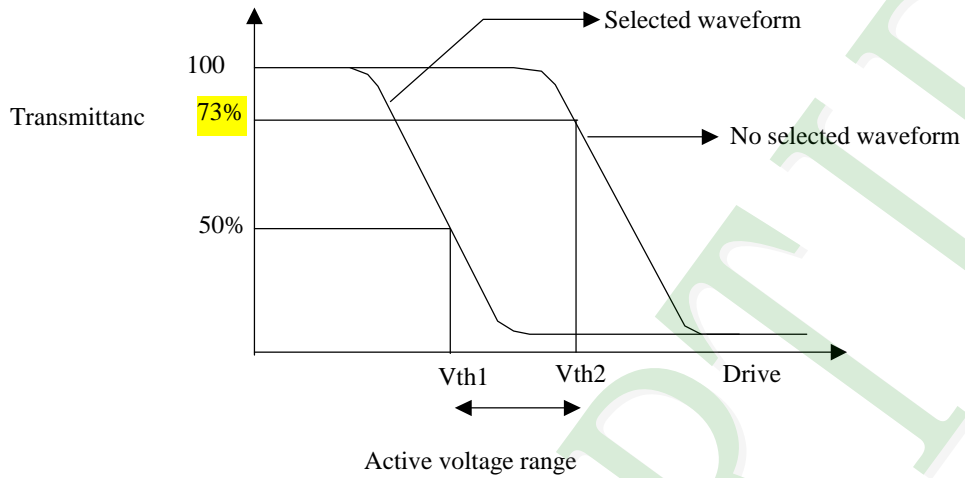

	V_{th1}	V_{th2}
View direction	10°	40°
Drive waveform	(Selected waveform)	(No selected waveform)
Transmittance	50%	73%

※1 Contrast ratio
 = (Brightness in OFF state) / (Brightness in ON state)

Outline of Electro-Optical Characteristics Measuring System

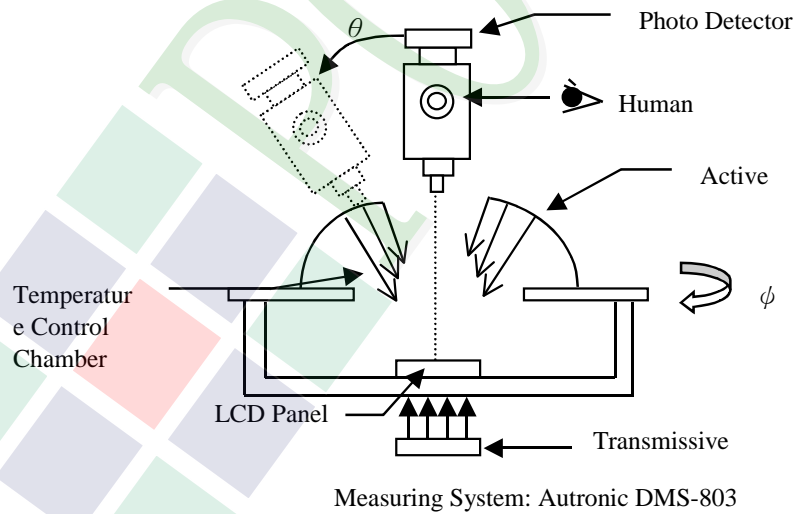

1.6 Backlight Characteristics

LCD Module with LED Backlight

Maximum Ratings

Item	Symbol	Conditions	Min.	Max.	Unit
Forward Current	IF	Ta =25°C	-	40	mA
Reverse Voltage	VR	Ta =25°C	-	8	V
Power Dissipation	PD	Ta =25°C	-	0.19	W

Electrical / Optical Characteristics

Item	Symbol	Conditions	Min.	Typ.	Max.	Unit
Forward Voltage	VF	IF=28 mA	-	4.2	4.8	V
Average Brightness (without LCD)	IV		4	5	-	cd/m ²
Wavelength	Hue		565	570	575	nm
Color	YELLOW-GREEN					

2. MODULE STRUCTURE

2.1 Counter Drawing

2.1.1 LCM Mechanical Diagram

* See Appendix

2.1.2 Block Diagram

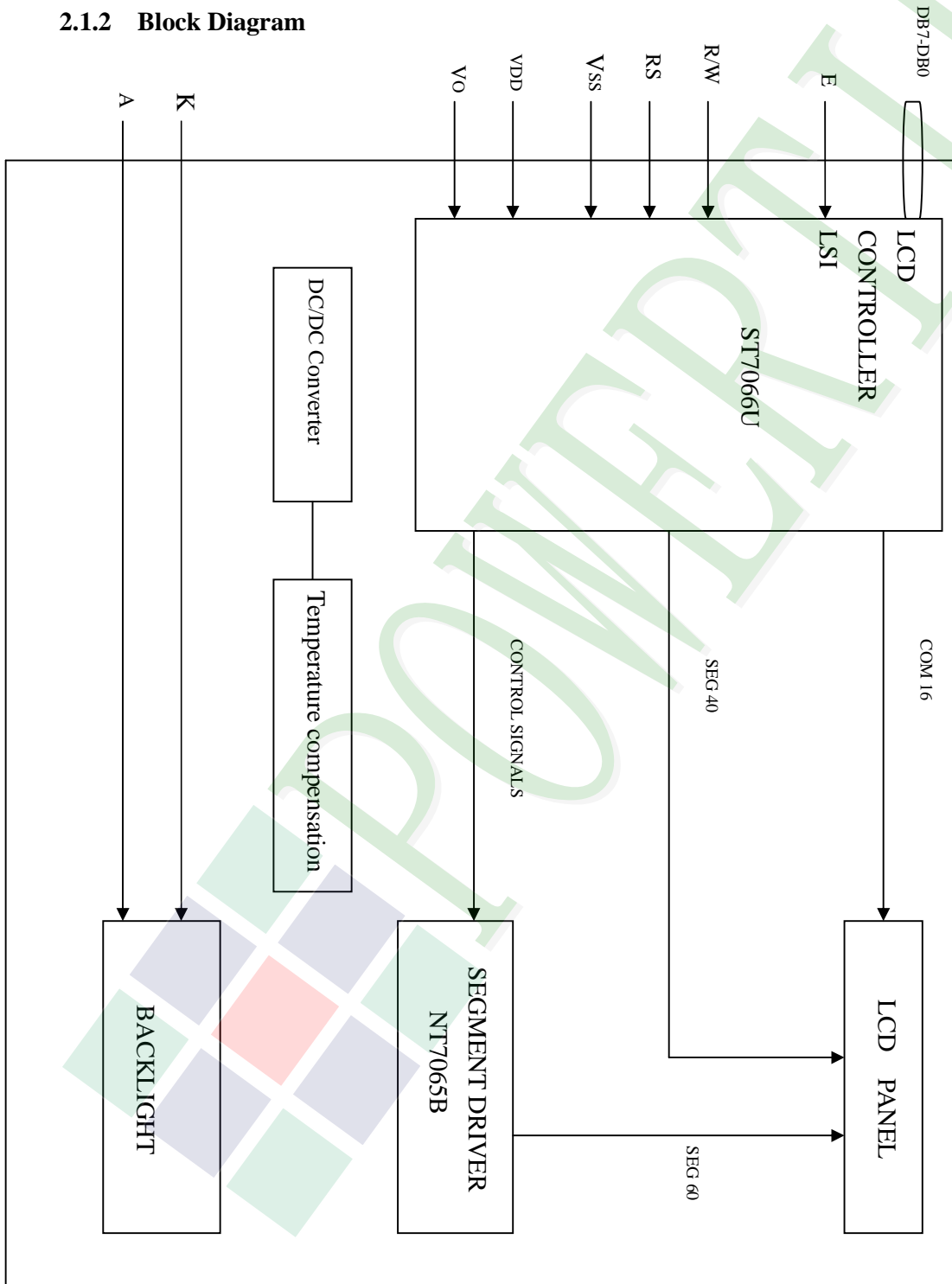

2.2 Interface Pin Description

Pin No.	Symbol	Signal Description
1	V _{SS}	Power Supply (V _{SS} =0)
2	V _{DD}	Power Supply (V _{DD} >V _{SS})
3	V _O	Operating voltage for LCD
4	RS	Register Selection input High = Data register Low = Instruction register (for write) Busy flag address counter (for read)
5	$\overline{\text{R/W}}$	Read/Write signal input is used to select the read/write mode High = Read mode, Low = Write mode
6	E	Start enable signal to read or write the data
7~10	DB0	Four low order bi-directional three-state data bus lines. Use for data transfer between the MPU and the LCD module. These four are not used during 4-bit operation.
	DB1	
	DB2	
	DB3	
11~14	DB4	Four high order bi-directional three-state data bus lines. Used for data transfer between the MPU and the LCD module. DB7 can be used as a busy flag.
	DB5	
	DB6	
	DB7	
15	A	Connect the anode of the back light
16	K	Connect the cathode of the back light

Contrast Adjust

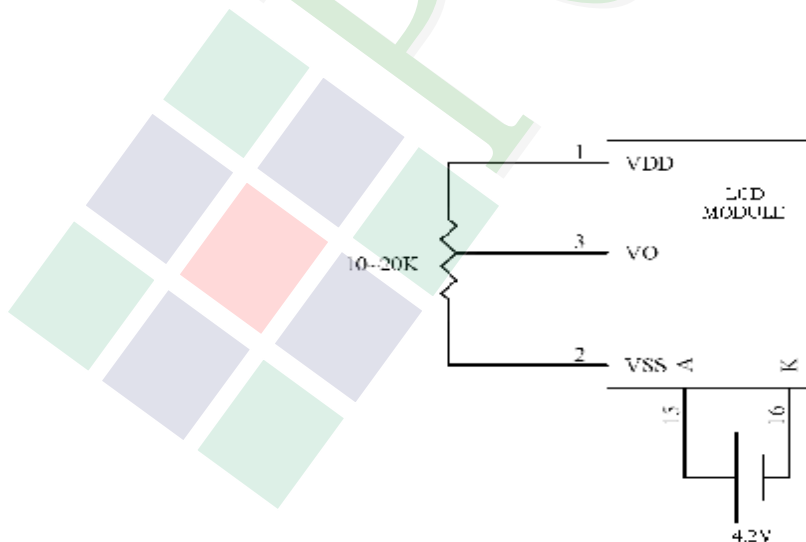

2.3 Timing Characteristics

- Writing data from MPU to ST7066U

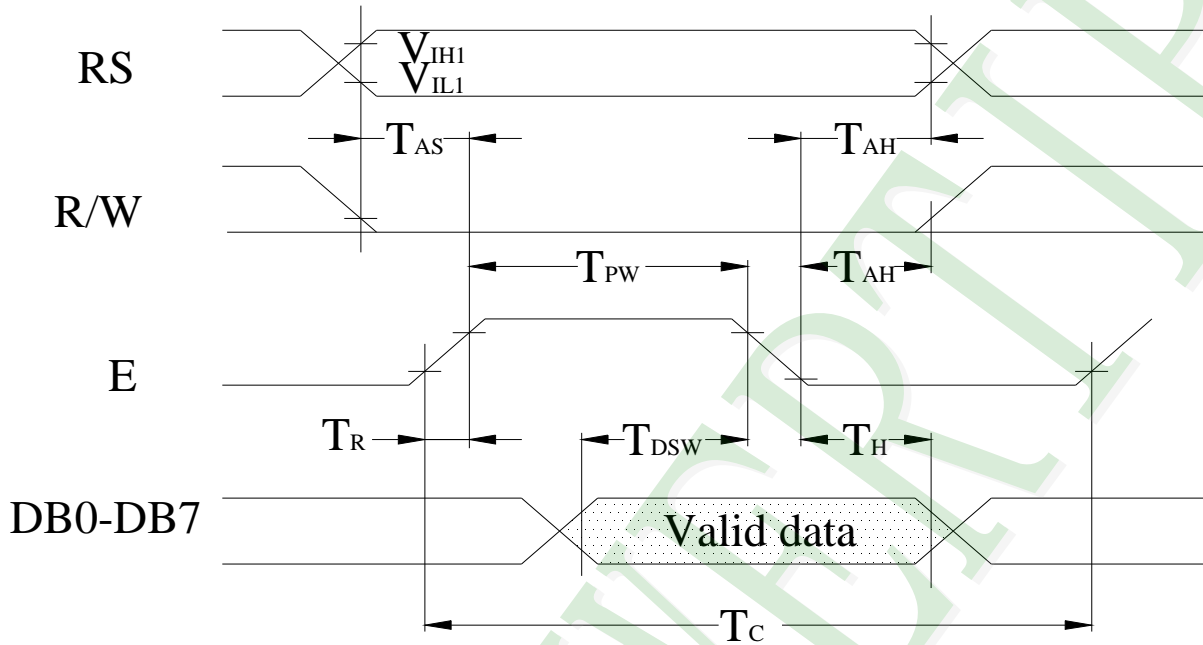

- I Reading data from ST7066U to MPU

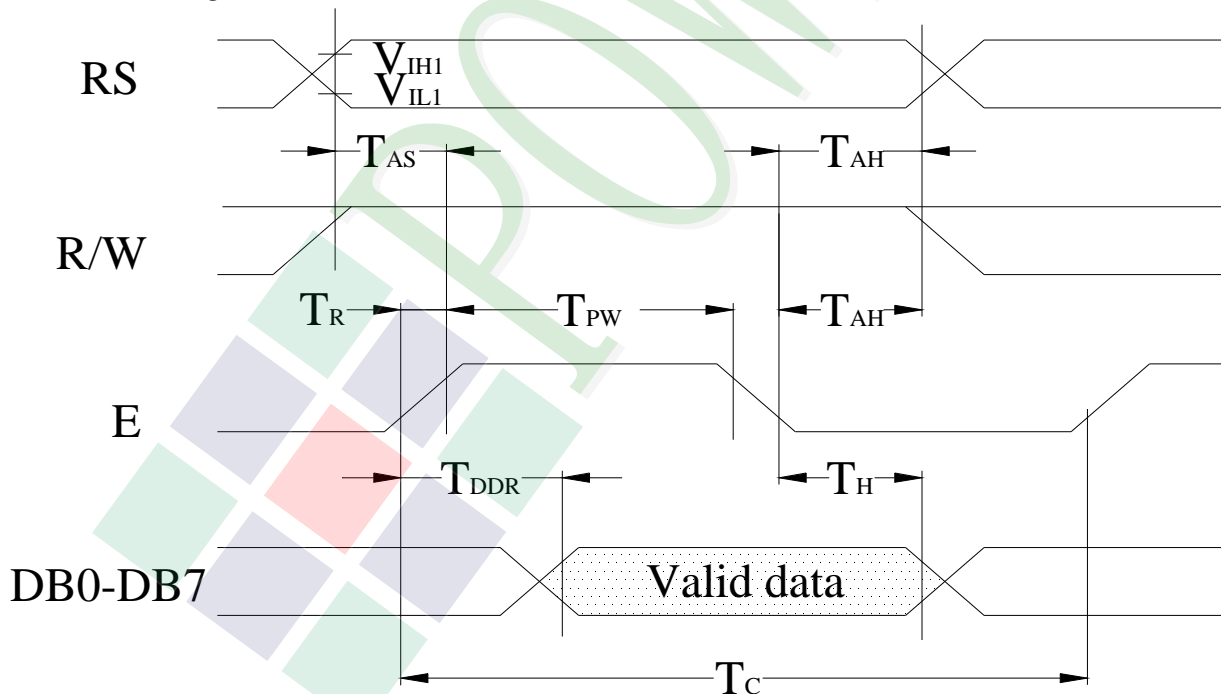

- Write Mode (Writing data from MPU to ST7066U)

 $V_{DD}=5V$ $T_a = 25^{\circ}C$

Symbol	Characteristics	Test Condition	Min.	Typ.	Max.	Unit
T_C	Enable Cycle Time	Pin E	1200	-	-	ns
T_{PW}	Enable Pulse Width	Pin E	140	-	-	ns
T_R, T_F	Enable Rise / Fall Time	Pin E	-	-	25	ns
T_{AS}	Address Setup Time	Pins: RS , RW,E	0	-	-	ns
T_{AH}	Address Hold Time	Pins :RS,RW,E	10	-	-	ns
T_{DSW}	Data Setup Time	Pins:DB0~DB7	40	-	-	ns
T_H	Data Hold Time	Pins:DB0~DB7	10	-	-	ns

- Read Mode (Reading data from ST7066U to MPU)

 $V_{DD}=5V$ $T_a = 25^{\circ}C$

Symbol	Characteristics	Test Condition	Min.	Typ.	Max.	Unit
T_C	Enable Cycle Time	Pin E	1200	-	-	ns
T_{PW}	Enable Pulse Width	Pin E	140	-	-	ns
T_R, T_F	Enable Rise / Fall Time	Pin E	-	-	25	ns
T_{AS}	Address Setup Time	Pins: RS , RW,E	0	-	-	ns
T_{AH}	Address Hold Time	Pins :RS,RW,E	10	-	-	ns
T_{DDR}	Data Setup Time	Pins:DB0~DB7	-	-	100	ns
T_H	Data Hold Time	Pins:DB0~DB7	10	-	-	ns

For 4-bit interface date, only four bus lines (DB4 to DB7) are used for transfer.

Example of busy flag check timing sequence

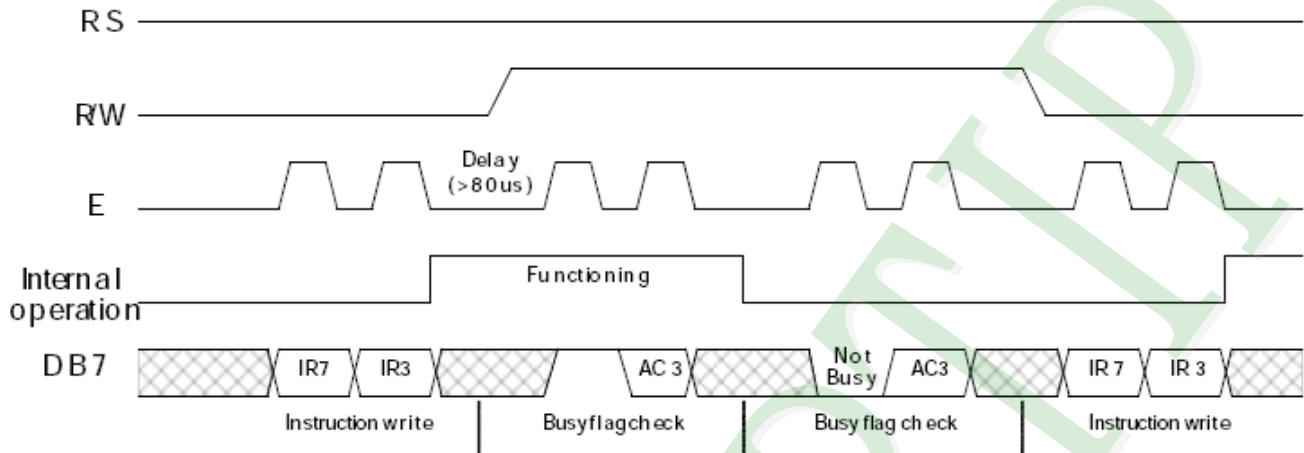

For 8-bit interface date, all eight bus lines (DB0 to DB7) are used .

Example of busy flag check timing sequence

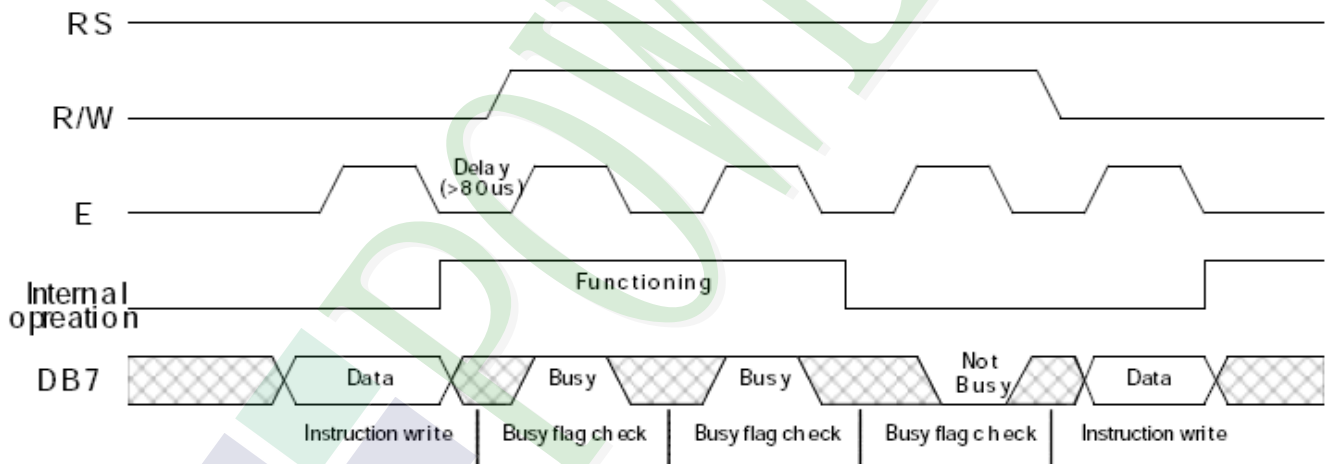

2.4 Character Pattern

NO.7066-0A

b7-b4 b3-b0	0000	0001	0010	0011	0100	0101	0110	0111	1000	1001	1010	1011	1100	1101	1110	1111	
0000	CG RAM (1)			0	a	P	\	P				-	9	3	0	p	
0001	(2)		!	1	A	Q	a	9			.	7	7	4	3	q	
0010	(3)		"	2	B	R	b	r			!	4	9	×	p	0	
0011	(4)		#	3	C	S	c	s			!	0	7	e	e	*	
0100	(5)		\$	4	D	T	d	t			\	I	T	+	p	a	
0101	(6)		%	5	E	U	e	u			.	+	+	1	0	0	
0110	(7)		&	6	F	V	f	v			!	0	2	0	p	Σ	
0111	(8)		'	7	G	W	g	w			!	+	×	7	g	π	
1000	(1)		(8	H	X	h	x			!	0	*	U	J	×	
1001	(2))	9	I	Y	i	y			!	0	7	U	W	Y	
1010	(3)		*	:	J	Z	j	z				!	0	0	V	J	7
1011	(4)		+	;	K	L	k	l				!	0	E	0	×	π
1100	(5)		,	<	L	#	l	l				!	0	0	0	0	π
1101	(6)		-	=	M	J	m	j				!	0	×	0	+	
1110	(7)		.	>	N	^	n	+				!	0	0	^	n	
1111	(8)		/	?	O	L	o	+				!	0	0	0	■	

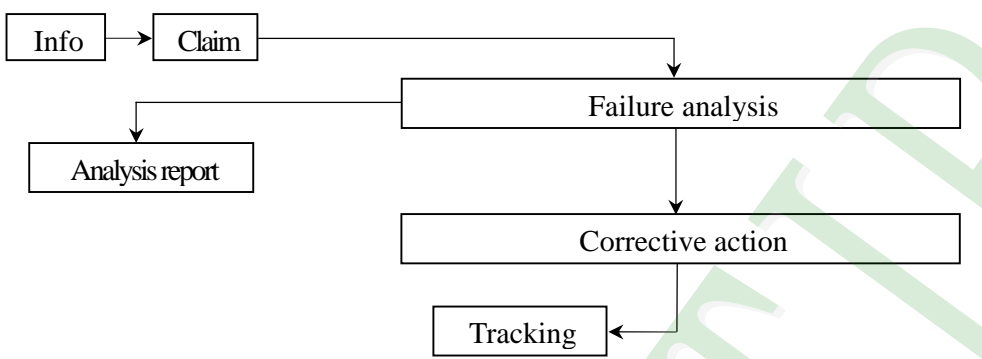
Item	Customer	Sales	R&D	Q.A	Manufacturing	Product control	Purchase	Inventory control
Sales Service	 <pre> graph TD Info[Info] --> Claim[Claim] Claim --> FA[Failure analysis] FA --> AR[Analysis report] FA --> CA[Corrective action] CA --> Tracking[Tracking] </pre>							
Q.A Activity	1. ISO 9001 Maintenance Activities 3. Equipment calibration 5. Standardization Management				2. Process improvement proposal 4. Education And Training Activities			

3.2 Inspection Specification

◆ **Scope** : The document shall be applied to LCD Module for Monotype and Color STN (Ver. 03).

◆ **Inspection Standard** : MIL-STD-105E Table Normal Inspection Single Sampling Level II .

◆ **Equipment** : Gauge , MIL-STD , Powertip Tester , Sample

◆ **Defect Level** : Major Defect AQL : 0.4 ; Minor Defect : AQL : 1.5 .

◆ **OUT Going Defect Level** : Sampling .

◆ **Manner of appearance test** :

(1). The test be under 20W×2 fluorescent light ' and distance of view must be at 30 cm.

(2). Standard of inspection : (Unit : mm)

(3). The test direction is base on about around 45° of vertical line. (Fig. 1)

(4). Definition of area . (Fig. 2)

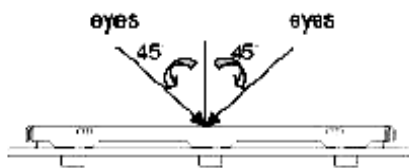

Fig.1

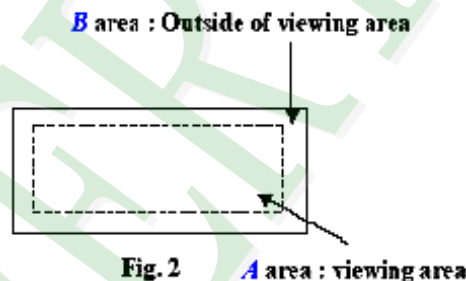
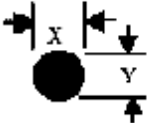
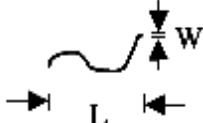

Fig. 2

◆ **Specification:**

NO	Item	Criterion	level
01	Product condition	1. 1 The part number is inconsistent with work order of Production.	Major
		1. 2 Mixed production types.	Major
		1. 3 Assembled in inverse direction.	Major
02	Quantity	2. 1 The quantity is inconsistent with work order of production.	Major
03	Outline dimension	3. 1 Product dimension and structure must conform to Structure diagram.	Major
04	Electrical Testing	4. 1 Missing line character and icon.	Major
		4. 2 No function or no display.	Major
		4. 3 Output data is error.	Major
		4. 4 LCD viewing angle defect.	Major
		4. 5 Current consumption exceeds product specifications.	Major

◆ Specification For Monotype and Color STN :
(Ver. 03)

NO	Item	Criterion	level																																					
05	<p>Black or white dot , scratch , contamination</p> <p>Round type</p>  <p>$\Phi = (x+y)/2$</p> <p>Line type</p> 	<p>5. 1 Round type:</p> <p>5. 1. 1 display only :</p> <ul style="list-style-type: none"> • White and black spots on display ≤ 0.30 mm , no more than 4 white or black spots present. • Densely spaced : NO more than two spots or lines within 3 mm. <p>5. 1. 2 Non-display :</p> <table border="1" data-bbox="537 617 1320 961"> <thead> <tr> <th rowspan="2">Dimension (diameter : Φ)</th> <th colspan="2">Acceptance (Q'ty)</th> </tr> <tr> <th>A area</th> <th>B area</th> </tr> </thead> <tbody> <tr> <td>$\Phi \leq 0.10$</td> <td colspan="2">Accept no dense</td> </tr> <tr> <td>$0.10 < \Phi \leq 0.20$</td> <td>3</td> <td rowspan="2">Ignore</td> </tr> <tr> <td>$0.20 < \Phi \leq 0.30$</td> <td>2</td> </tr> <tr> <td>Total quantity</td> <td colspan="2">4</td> </tr> </tbody> </table> <p>5. 1. 3 Line type:</p> <table border="1" data-bbox="492 1041 1365 1377"> <thead> <tr> <th colspan="2">Dimension</th> <th colspan="2">Acceptance (Q'ty)</th> </tr> <tr> <th>Length (L)</th> <th>Width (W)</th> <th>A area</th> <th>B area</th> </tr> </thead> <tbody> <tr> <td>---</td> <td>$W \leq 0.03$</td> <td>Accept no dense</td> <td rowspan="3">Ignore</td> </tr> <tr> <td>$L \leq 3.0$</td> <td>$0.03 < W \leq 0.05$</td> <td rowspan="2">4</td> </tr> <tr> <td>$L \leq 2.5$</td> <td>$0.05 < W \leq 0.075$</td> </tr> <tr> <td>---</td> <td>$W > 0.075$</td> <td colspan="2">As round type</td> </tr> </tbody> </table>	Dimension (diameter : Φ)	Acceptance (Q'ty)		A area	B area	$\Phi \leq 0.10$	Accept no dense		$0.10 < \Phi \leq 0.20$	3	Ignore	$0.20 < \Phi \leq 0.30$	2	Total quantity	4		Dimension		Acceptance (Q'ty)		Length (L)	Width (W)	A area	B area	---	$W \leq 0.03$	Accept no dense	Ignore	$L \leq 3.0$	$0.03 < W \leq 0.05$	4	$L \leq 2.5$	$0.05 < W \leq 0.075$	---	$W > 0.075$	As round type		Minor
Dimension (diameter : Φ)	Acceptance (Q'ty)																																							
	A area	B area																																						
$\Phi \leq 0.10$	Accept no dense																																							
$0.10 < \Phi \leq 0.20$	3	Ignore																																						
$0.20 < \Phi \leq 0.30$	2																																							
Total quantity	4																																							
Dimension		Acceptance (Q'ty)																																						
Length (L)	Width (W)	A area	B area																																					
---	$W \leq 0.03$	Accept no dense	Ignore																																					
$L \leq 3.0$	$0.03 < W \leq 0.05$	4																																						
$L \leq 2.5$	$0.05 < W \leq 0.075$																																							
---	$W > 0.075$	As round type																																						
06	Polarizer Bubble	<table border="1" data-bbox="492 1440 1362 1829"> <thead> <tr> <th rowspan="2">Dimension (diameter : Φ)</th> <th colspan="2">Acceptance (Q'ty)</th> </tr> <tr> <th>A area</th> <th>B area</th> </tr> </thead> <tbody> <tr> <td>$\Phi \leq 0.20$</td> <td colspan="2">Accept no dense</td> </tr> <tr> <td>$0.20 < \Phi \leq 0.50$</td> <td>3</td> <td rowspan="3">Ignore</td> </tr> <tr> <td>$0.50 < \Phi \leq 1.00$</td> <td>2</td> </tr> <tr> <td>$\Phi > 1.00$</td> <td>0</td> </tr> <tr> <td>Total quantity</td> <td colspan="2">4</td> </tr> </tbody> </table>	Dimension (diameter : Φ)	Acceptance (Q'ty)		A area	B area	$\Phi \leq 0.20$	Accept no dense		$0.20 < \Phi \leq 0.50$	3	Ignore	$0.50 < \Phi \leq 1.00$	2	$\Phi > 1.00$	0	Total quantity	4		Minor																			
Dimension (diameter : Φ)	Acceptance (Q'ty)																																							
	A area	B area																																						
$\Phi \leq 0.20$	Accept no dense																																							
$0.20 < \Phi \leq 0.50$	3	Ignore																																						
$0.50 < \Phi \leq 1.00$	2																																							
$\Phi > 1.00$	0																																							
Total quantity	4																																							

◆ Specification For Monotype and Color STN :

(Ver. 03)

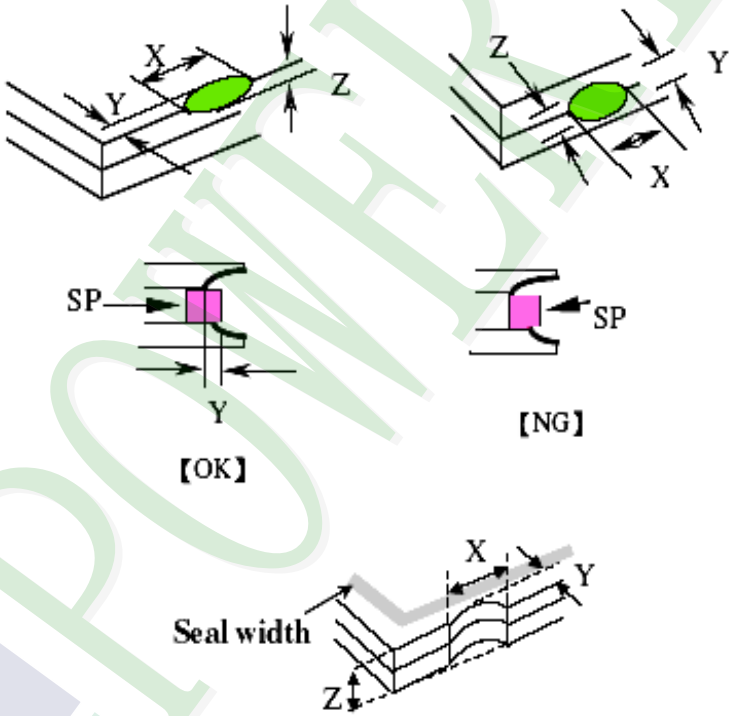
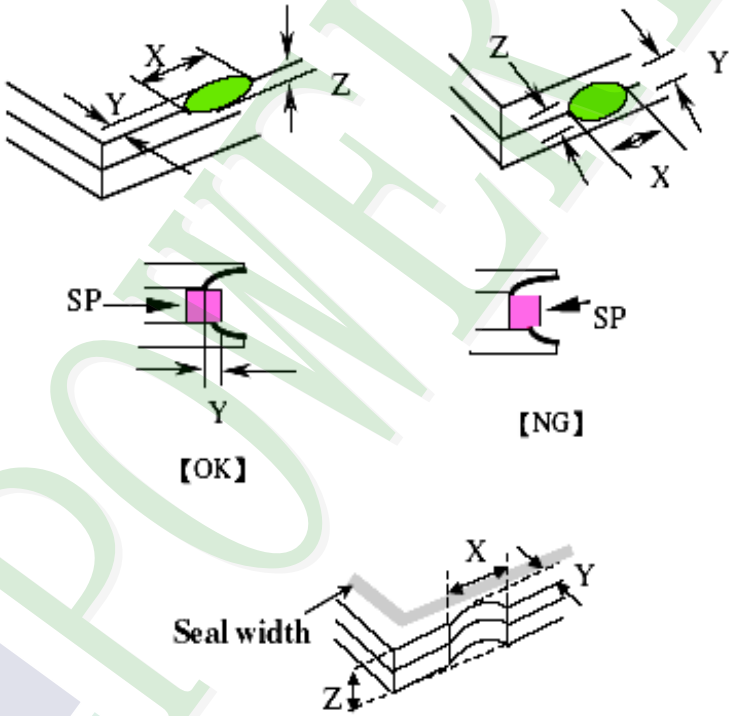
NO	Item	Criterion	Level									
07	The crack of glass	<p>Symbols :</p> <p>X : The length of crack Y : The width of crack. Z : The thickness of crack W : terminal length t : The thickness of glass a : LCD side length</p> <hr/> <p>7.1 General glass chip :</p> <p>7.1.1 Chip on panel surface and crack between panels:</p>  <table border="1" data-bbox="560 1528 1333 1829"> <thead> <tr> <th>X</th> <th>Y</th> <th>Z</th> </tr> </thead> <tbody> <tr> <td>$\cong a$</td> <td>Crack can't enter viewing area</td> <td>$\leq 1/2 t$</td> </tr> <tr> <td>$\leq a$</td> <td>Crack can't exceed the half of SP width.</td> <td>$1/2 t < Z \leq 2 t$</td> </tr> </tbody> </table>	X	Y	Z	$\cong a$	Crack can't enter viewing area	$\leq 1/2 t$	$\leq a$	Crack can't exceed the half of SP width.	$1/2 t < Z \leq 2 t$	Minor
		X	Y	Z								
$\cong a$	Crack can't enter viewing area	$\leq 1/2 t$										
$\leq a$	Crack can't exceed the half of SP width.	$1/2 t < Z \leq 2 t$										
<p>7.1.1 Chip on panel surface and crack between panels:</p>  <table border="1" data-bbox="560 1528 1333 1829"> <thead> <tr> <th>X</th> <th>Y</th> <th>Z</th> </tr> </thead> <tbody> <tr> <td>$\cong a$</td> <td>Crack can't enter viewing area</td> <td>$\leq 1/2 t$</td> </tr> <tr> <td>$\leq a$</td> <td>Crack can't exceed the half of SP width.</td> <td>$1/2 t < Z \leq 2 t$</td> </tr> </tbody> </table>	X	Y	Z	$\cong a$	Crack can't enter viewing area	$\leq 1/2 t$	$\leq a$	Crack can't exceed the half of SP width.	$1/2 t < Z \leq 2 t$			
X	Y	Z										
$\cong a$	Crack can't enter viewing area	$\leq 1/2 t$										
$\leq a$	Crack can't exceed the half of SP width.	$1/2 t < Z \leq 2 t$										

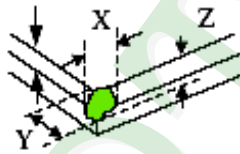
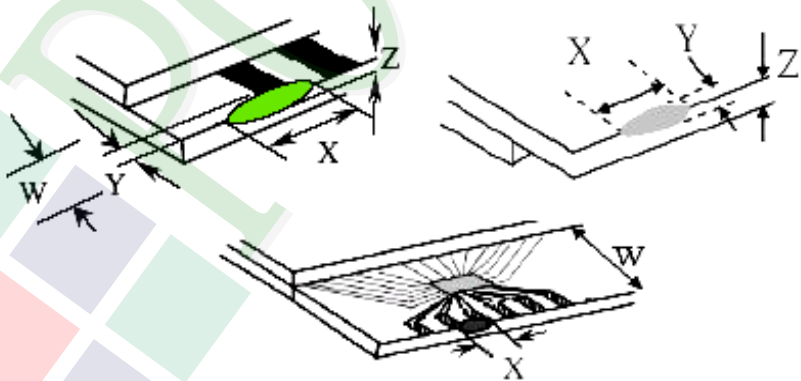
NO	Item	Criterion	Level										
07	The crack of glass	<p>Symbols :</p> <p>X : The length of crack Y : The width of crack. Z : The thickness of crack W : terminal length t : The thickness of glass a : LCD side length</p> <hr/> <p>7.1.2 Corner crack :</p>  <table border="1" data-bbox="553 793 1320 1083"> <thead> <tr> <th>X</th> <th>Y</th> <th>Z</th> </tr> </thead> <tbody> <tr> <td>$\leq 1/5 a$</td> <td>Crack can't enter viewing area</td> <td>$Z \leq 1/2 t$</td> </tr> <tr> <td>$\leq 1/5 a$</td> <td>Crack can't exceed the half of SP width.</td> <td>$1/2 t < Z \leq 2 t$</td> </tr> </tbody> </table>	X	Y	Z	$\leq 1/5 a$	Crack can't enter viewing area	$Z \leq 1/2 t$	$\leq 1/5 a$	Crack can't exceed the half of SP width.	$1/2 t < Z \leq 2 t$	Minor	
		X	Y	Z									
$\leq 1/5 a$	Crack can't enter viewing area	$Z \leq 1/2 t$											
$\leq 1/5 a$	Crack can't exceed the half of SP width.	$1/2 t < Z \leq 2 t$											
<p>7.2 Protrusion over terminal :</p> <p>7.2.1 Chip on electrode pad :</p>  <table border="1" data-bbox="521 1661 1263 1833"> <thead> <tr> <th></th> <th>X</th> <th>Y</th> <th>Z</th> </tr> </thead> <tbody> <tr> <td>Front</td> <td>$\leq a$</td> <td>$\leq 1/2 W$</td> <td>$\leq t$</td> </tr> <tr> <td>Back</td> <td colspan="3">Neglect</td> </tr> </tbody> </table>		X	Y	Z	Front	$\leq a$	$\leq 1/2 W$	$\leq t$	Back	Neglect			
	X	Y	Z										
Front	$\leq a$	$\leq 1/2 W$	$\leq t$										
Back	Neglect												

◆ Specification For Monotype and Color STN :

(Ver. 03)

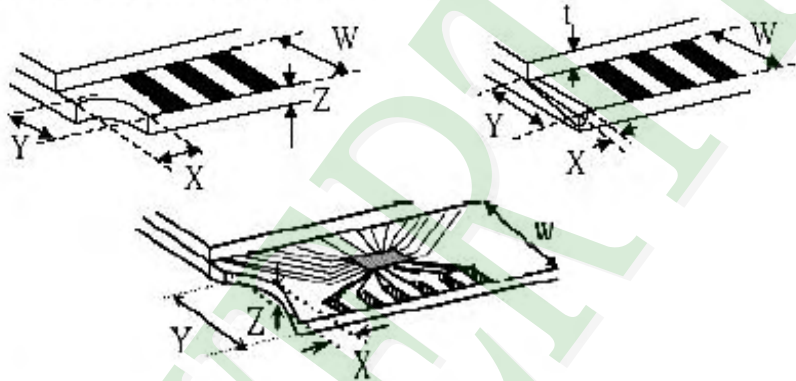
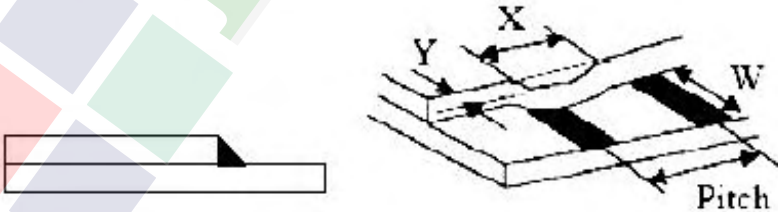
NO	Item	Criterion	Level												
07	The crack of glass	<p>Symbols :</p> <p>X : The length of crack Y : The width of crack. Z : The thickness of crack W : terminal length t : The thickness of glass a : LCD side length</p> <hr/> <p>7.2.2 Non-conductive portion :</p>  <table border="1" data-bbox="620 1045 1218 1201"> <thead> <tr> <th>X</th> <th>Y</th> <th>Z</th> </tr> </thead> <tbody> <tr> <td>$\leq 1/3 a$</td> <td>$\leq W$</td> <td>$\leq t$</td> </tr> </tbody> </table> <p>⊙ If the chipped area touches the ITO terminal, over 2/3 of the ITO must remain and be inspected according to electrode terminal specifications.</p> <p>7.2.3 Glass remain :</p>  <table border="1" data-bbox="545 1738 1201 1881"> <thead> <tr> <th>X</th> <th>Y</th> <th>Z</th> </tr> </thead> <tbody> <tr> <td>$\leq a$</td> <td>$\leq 1/3 W$</td> <td>$\leq t$</td> </tr> </tbody> </table>	X	Y	Z	$\leq 1/3 a$	$\leq W$	$\leq t$	X	Y	Z	$\leq a$	$\leq 1/3 W$	$\leq t$	Minor
X	Y	Z													
$\leq 1/3 a$	$\leq W$	$\leq t$													
X	Y	Z													
$\leq a$	$\leq 1/3 W$	$\leq t$													

◆ Specification For Monotype and Color STN :

(Ver. 03)

NO	Item	Criterion	Level
08	Backlight elements	8. 1 Backlight can't work normally.	Major
		8. 2 Backlight doesn't light or color is wrong.	Major
		8. 3 Illumination source flickers when lit.	Major
09	General appearance	9. 1 Pin type must match type in specification sheet.	Major
		9. 2 No short circuits in components on PCB or FPC.	Major
		9. 3 Product packaging must the same as specified on packaging specification sheet.	Minor
		9. 4 The folding and peeled off in polarizer are not acceptable.	Minor
		9. 5 The PCB or FPC between B/L assembled distance (PCB or FPC) is ≤ 1.5 mm.	Minor

5. PRECAUTION RELATING PRODUCT HANDLING

5.1 SAFETY

- 5.1.1 If the LCD panel breaks , be careful not to get the liquid crystal to touch your skin.
- 5.1.2 If the liquid crystal touches your skin or clothes , please wash it off immediately by using soap and water.

5.2 HANDLING

- 5.2.1 Avoid any strong mechanical shock which can break the glass.
- 5.2.2 Avoid static electricity which can damage the CMOS LSI—When working with the module , be sure to ground your body and any electrical equipment you may be using.
- 5.2.3 Do not remove the panel or frame from the module.
- 5.2.4 The polarizing plate of the display is very fragile. So , please handle it very carefully ,do not touch , push or rub the exposed polarizing with anything harder than an HB pencil lead (glass , tweezers , etc.)
- 5.2.5 Do not wipe the polarizing plate with a dry cloth , as it may easily scratch the surface of plate.
- 5.2.6 Do not touch the display area with bare hands , this will stain the display area.
- 5.2.7 Do not use ketonics solvent & aromatic solvent. Use with a soft cloth soaked with a cleaning naphtha solvent.
- 5.2.8 To control temperature and time of soldering is $320\pm 10^{\circ}\text{C}$ and 3-5 sec.
- 5.2.9 To avoid liquid (include organic solvent) stained on LCM .

5.3 STORAGE

- 5.3.1 Store the panel or module in a dark place where the temperature is $25^{\circ}\text{C} \pm 5^{\circ}\text{C}$ and the humidity is below 65% RH.
- 5.3.2 Do not place the module near organics solvents or corrosive gases.
- 5.3.3 Do not crush , shake , or jolt the module.

5.4 TERMS OF WARRANTY

- 5.4.1 Applicable warrant period
The period is within thirteen months since the date of shipping out under normal using and storage conditions.
- 5.4.2 Unaccepted responsibility
This product has been manufactured to your company's specification as a part for use in your company's general electronic products. It is guaranteed to perform according to delivery specifications. For any other use apart from general electronic equipment , we cannot take responsibility if the product is used in nuclear power control equipment , aerospace equipment , fire and security systems or any other applications in which there is a direct risk to human life and where extremely high levels of reliability are required.

Ver.001

Documents NO.

JPKG-PC1602LRS-KWA-HY8Q

LCM包裝規格書

LCM Packaging Specifications

Approve

Check

Contact

Ryan

Eddy

Tang yunxian

1. 包裝材料規格表 (Packaging Material) : (per carton)

No.	Item	Model	Dimensions (mm)	1Pcs Weight	Quantity	Total Weight
1	成品(1) (LCM)	PC1602LRS-KWA-HY8Q	53*20*8.1	0.025	540	13.5
2	靜電袋 (2)BAG	BAG100100ARABA	100*100*0.05	0.002	540	1.08
3	氣泡墊(3)BAG	BAG290240BRBBA	240*290*5	0.0029	24	0.0696
4	刀卡A1(4)BX	BX29500047BZBA	295*47*3	0.0069	168	1.1592
5	刀卡B1(5)BX	BX24500047BZBA	245*47*4.5	0.009	48	0.432
6	C1內盒(6)Product Box	BX31025555AABA	310*255*55	0.1101	12	1.3212
7	外紙箱(7)Carton	BX52532536CCBA	525*325*360	1.092	1	1.092
8						
9						

2. 一整箱總重量 (Total LCD Weight in carton) : 18.65 Kg±10%

3. 單箱數量規格表 (Packaging Specifications and Quantity) :

(1)Quantity Of Spacer : A1刀卡 * 14 , B1刀卡 * 4

(2)Total LCM quantity in carton : quantity per box 45 x no. of boxes 12 = 540

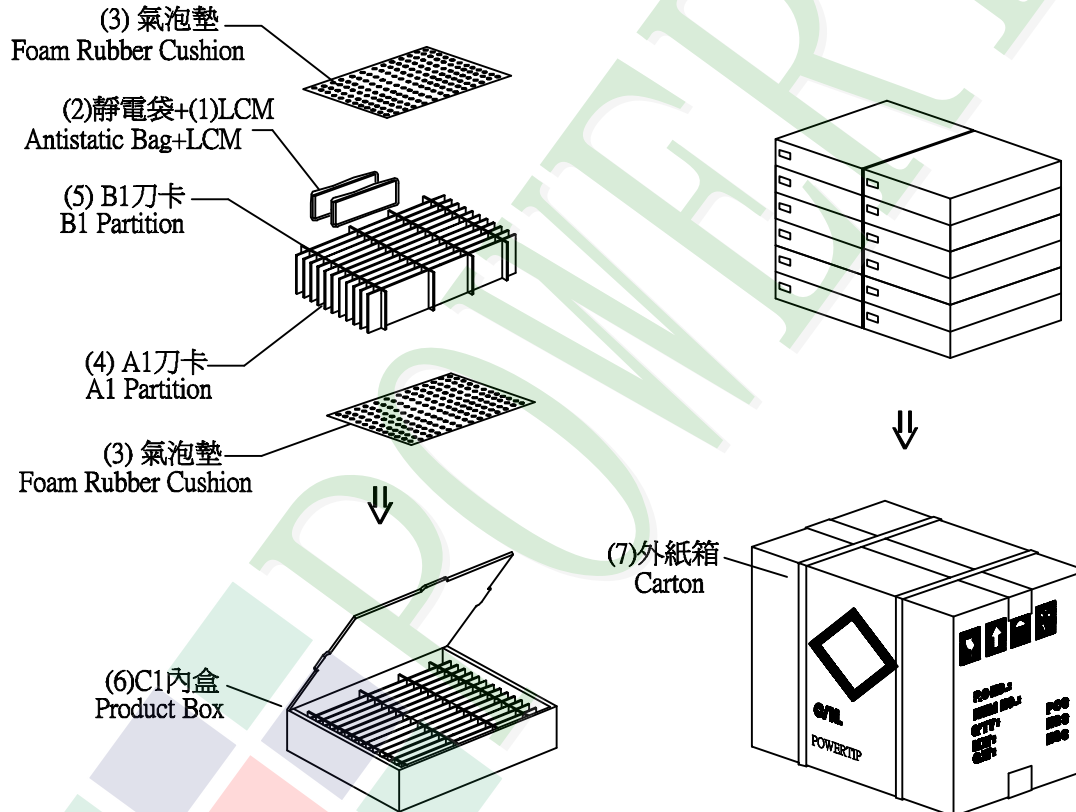

特 記 事 項 (REMARK)

1. Label Specifications :

MODEL:
LOT NO:
QUANTITY:
CHECK: